



SECTIONAL GARAGE DOORS

NEW. Elegant door view with smooth Plainrain surface in matt fine structure



HÖRMANN



4



16



54



Content

- 4 Good reasons to try Hörmann**

- 16 Inspirations**
- 18 Steel doors
- 42 Glazed doors
- 44 Facade doors / large doors
- 46 Solid timber doors
- 48 Hinged garage doors
- 50 Doors and accessories

- 54 Design, equipment, accessories**
- 56 Steel sectional doors
- 60 Design elements and VarioDesign
- 61 Surface finishes
- 70 Aluminium frame doors
- 71 Glazings
- 72 Solid timber sectional doors
- 74 Equipment
- 78 Wicket doors
- 80 Side doors
- 82 Hinged garage doors
- 84 Operators
- 86 Accessories
- 88 Dimensions and technical manual

Responsibility for generations

The Hörmann family business has over 90 years of experience as a construction component specialist. This gives us an obligation to both current and future generations. That's why environmental responsibility plays such an important role for us. With this in mind, we develop innovative solutions for sustainable products and intelligent environmental protection.



“A GOOD REPUTATION MUST BE EARNED.”

August Hörmann

In keeping with the tradition started by the company's founder, the Hörmann brand is a true promise of quality and, with sales of over 20 million doors, door frames and operators, is one of Europe's most successful suppliers. Due to the comprehensive international sales and service network, Hörmann is your strong partner for high-quality construction components.



WE THINK AND ACT GREEN. As a family business, we are very conscious of our responsibility to future generations and offer all products for residential construction CO₂-neutral as standard. The Hörmann sustainability strategy aims to reduce and avoid emissions. We cover 100% of our electrical power needs at all European production sites with genuine green electricity from renewable sources. We also apply many other measures to reduce our consumption and save more than 75000 tonnes of CO₂ each year. We work with ClimatePartner to offset the remaining emissions by supporting certified climate protection projects.



You can find further information at
www.hoermann.com/sustainability



ClimatePartner
certified product
climate-id.com/XNEBKC



CO₂
measure
reduce
contribute

Brand quality made in Germany



The family-owned company Hörmann offers all important construction components for building and renovating projects from a single source. We manufacture in highly specialised factories using state-of-the-art production technologies. Our employees work intensively on new products, continual further developments and improvements to details. The results are patents and unique products you can depend on.





**10 years
Guarantee***

LONG-LASTING. GUARANTEED. All major door and operator components are developed and manufactured by Hörmann. Endurance tests under real conditions ensure mature series products with Hörmann quality. Thanks to this and uncompromising quality assurance, you receive a 10-year warranty on all Hörmann sectional doors and a 5-year warranty on Hörmann operators*.

* The complete warranty conditions can be found at: www.hoermann.com



**Tested and
certified**

Certified safety for you and your family. Hörmann sectional doors are tested and certified in accordance with the high safety requirements of European standard 13241, not only on their own but also in combination with Hörmann operators. It would be hard to find a safer sectional door. This provides you and your family with safety during daily use.



Innovative details – Only from Hörmann



We aim to offer you the best and most elegant door solution for your home. That's why we refine each and every detail in the development of our sectional garage doors, creating innovations that are exclusive to Hörmann. To achieve a harmonious door appearance, Hörmann ensures that the ribbing and section transitions are evenly distributed at every door height.



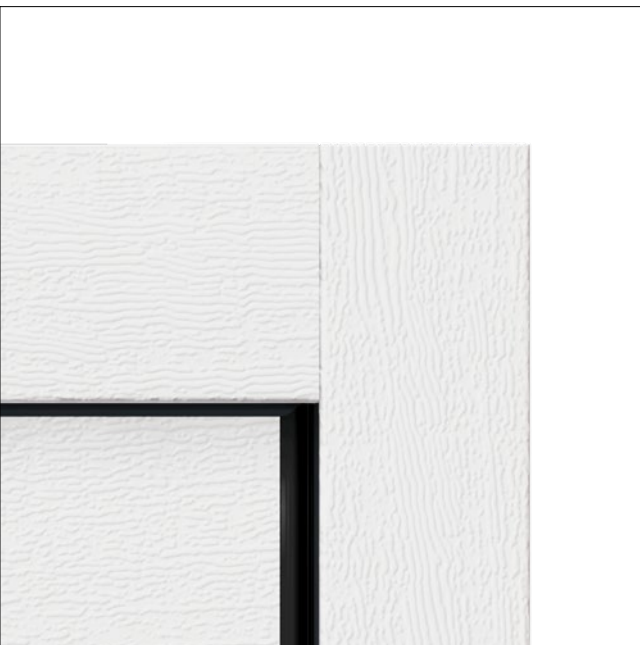

Only from Hörmann

■ Matching appearance of door frame and door leaf

MATCHING APPEARANCE OF DOOR FRAMES AND DOOR LEAF. Harmonious door appearance from the fascia panel to the door sections. With frame coverings, the side frames can be easily adapted to the surface finish of the sections.

→ Further information can be found starting on page 69.



Only from Hörmann

■ Plastic frame shoe

PLASTIC FRAME SHOE. A non-brittle, 4 cm plastic frame shoe covers the frame where it is prone to rusting and offers long-term protection against corrosion, even in the event of prolonged waterlogging.

→ Further information can be found starting on page 75.



Only from Hörmann

■ Duratec glazing

DURATEC SYNTHETIC GLAZING. The clear plastic glazing is extremely scratch-resistant as standard and offers you a permanently clear view and improved thermal insulation.

→ Further information can be found starting on page 71.

Space-saving opening and securely closed

Sectional garage doors open vertically upwards and are suspended under the ceiling to save space. This construction principle means you can make full use of the space inside and in front of the garage. Sectional garage doors can be fitted in any garage opening and offer extra passage width. Treat yourself to this comfort and convenience.





CERTIFIED RC2 SECURITY FEATURES.

In addition to the standard anti-lift kit, which automatically locks your door securely and protects it against being forced open, all sectional garage doors, wicket as well as side doors are optionally available with certified RC2 security features.

- Further information can be found starting on page 77.
- Watch the video on YouTube or at www.hormann.co.uk/media-centre

MORE PASSAGE WIDTH. Sectional doors with a passage width extended by up to 14 cm also make it much easier to park modern, larger vehicles and SUVs (shown in centre). With older up-and-over doors, driving in and out is often a matter of millimetres (shown at the bottom).

Intelligent operating comfort

Control your garage door and entrance gate operators, door operators, entrance door locks, lights and other devices simply, safely and conveniently via hand transmitter, radio control button or smartphone. All operators, receivers and control elements with BiSecur radio technology are 100% compatible with each other.





Only from Hörmann

CERTIFIED SAFETY. The bidirectional radio system BiSecur with particularly secure encryption protocol and stable, interference-free range makes sure that no one can copy your radio signal. This is also confirmed by the security experts of Bochum University and independent test institutes.

→ Watch the video on YouTube or at www.hormann.co.uk/media-centre

INTELLIGENT TECHNOLOGY. Hörmann operators offer more convenience, smart functions and intelligent technology. The automatic safety cut-out stops the door securely and reliably if it encounters an obstacle. Your door opens and closes quietly and smoothly with the soft start and soft stop. Our elegant hand transmitters allow you to open your door from your car, for example. Or you can simply use your smartphone as a door opener with the Hörmann BlueSecur app.

→ Further information can be found starting on page 84.

Thanks to the automatic safety cut-out as standard children can play in your yard without worrying.



Choose the door, that suits your home

No matter the architectural style, with Hörmann, you are guaranteed to find a sectional garage door style to fit your personal preferences and home – from straight-lined ribbing to classic panelling in many surface finishes, colours and decors, as well as solid timber doors. Be inspired by the Hörmann variety on the following pages or configure your dream door conveniently online.



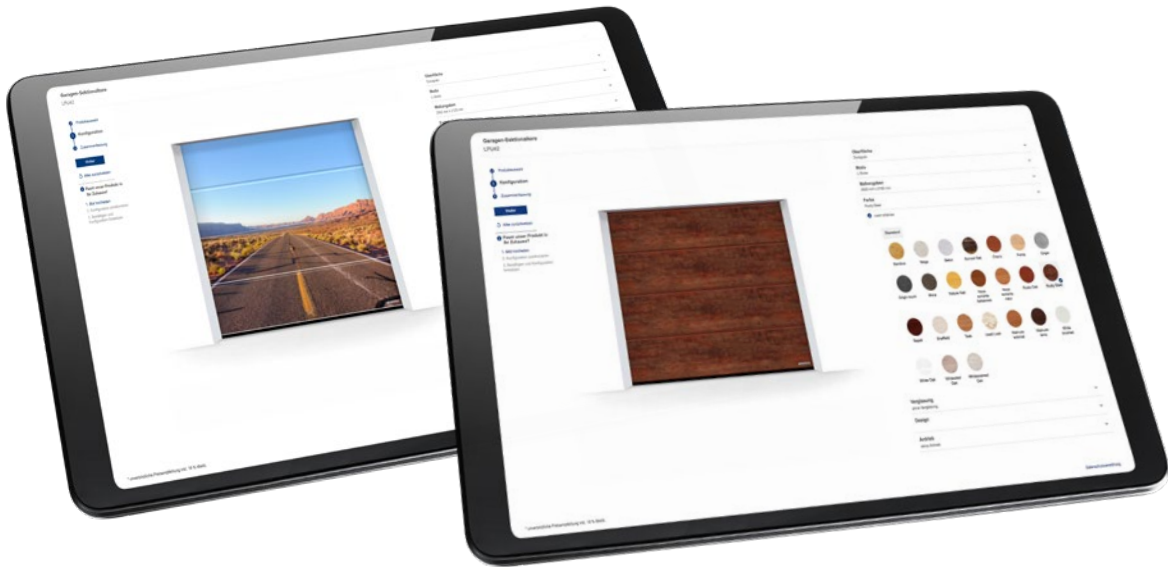

THE DOOR OF YOUR CHOICE IN JUST A FEW CLICKS. With the door configurator, you can conveniently test many design and product variations on your own PC or tablet in advance. You can put your dream door together in just a few clicks by selecting the door type, surface finish, colour and size and also see the recommended retail price of your configuration (shown on the top right). If you then upload a picture of your house and place the door in your garage opening, you can see in advance how well your new garage door will match your home.

DURAGRAIN INDIVIDUAL PRINT. You can also design the sectional garage doors with Duragrain surface finish yourself by using a custom image (shown on the top left). Simply upload the image into the configurator or contact your Hörmann sales partner.

→ The Hörmann configurator can be found at:

www.hormann.co.uk/home-owners-and-renovators/configurator



GERMANY'S BEST-SELLING GARAGE DOOR. More than 5 million customers are convinced of the convenience, safety and design of Hörmann sectional garage doors.





Inspirations

18 Steel door styles

18 L-ribbed

20 M-ribbed

22 S-ribbed

24 D-ribbed

26 S-panelled

28 Steel door surface finishes

28 Slategrain surface finish

30 Plaingrain surface

32 Woodgrain surface finish

34 Silkgrain surface finish

Door and garage door in
a matching look

38 Decograin surface finish

40 Duragrain surface finish

42 Glazed doors

44 Facade doors / large doors

46 Solid timber doors

48 Hinged garage doors

50 Doors and accessories



L-ribbed

This elegant door style is available in a wide choice of surface finishes to suit your individual design preferences. The expansive door view shows off the L-ribbing to perfection, especially on wide doors up to 6000 mm.

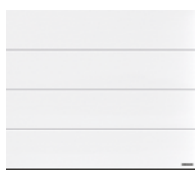

→ Available in the surfaces Slategrain, Plaingrain, Woodgrain, Silkgrain, Decograin and Duragrain. Further information can be found starting on pages 28 and 58.



PAGE 16 / 17. L-ribbed, Silkgrain, Anthracite Metallic CH 703-AM

TOP LEFT. **NEW.** L-ribbed, Plaingrain Anthracite grey matt fine structure RAL 7016

TOP RIGHT. L-ribbed, Silkgrain, Jet black RAL 9005, VarioDesign with Duragrain MatchDecor Barnwood, aluminium entrance door ThermoSafe style 878, Jet black RAL 9005, application in MatchDecor Barnwood, with side elements and transom light

BOTTOM. L-ribbed, Silkgrain, Traffic white RAL 9016





TOP LEFT. M-ribbed, Decograin Golden Oak

TOP RIGHT. M-ribbed, Woodgrain,
Slate grey RAL 7015

BOTTOM. **NEW.** M-ribbed, Slategrain Traffic white
matt fine structure RAL 9016





M-ribbed

The M-ribbing impresses with its contemporary door design, making it ideal for both renovations and new constructions. With a wide range of surface finishes, colours and decors to choose from, you can match your garage door perfectly to the doors and windows of your home.

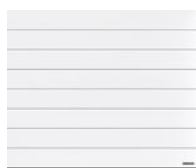

→ Available in Slategrain, Plaingrain, Woodgrain, Silkgrain and Decograin surfaces. Further information can be found starting on pages 28 and 58.



S-ribbed

For budget-conscious builders, this door style boasts a timeless design that complements a variety of architectural styles. When the door is closed, the transitions between the individual sections are practically invisible and, in combination with the ribbings, create a harmonious appearance.



→ Available in the Woodgrain surface. Further information can be found on page 28 and from page 58.



LEFT. S-ribbed Woodgrain, Fir green RAL 6009

TOP RIGHT. S-ribbed, Woodgrain Traffic white RAL 9016 with matching side door

BOTTOM RIGHT. S-ribbed Woodgrain, Anthracite grey RAL 7016 with matching appearance side door and Hörmann ThermoSafe style 501 aluminium entrance door, anthracite grey RAL 7016



TOP. D-ribbed, Silkgrain, Grey aluminium RAL 9007, Hörmann aluminium entrance door ThermoSafe style 872, Grey aluminium RAL 9007

BOTTOM LEFT. D-ribbed, Silkgrain, Anthracite grey RAL 7016 with "House number" design element, Hörmann aluminium entrance door ThermoSafe style 860 in Anthracite grey RAL 7016

BOTTOM RIGHT. D-ribbed Silkgrain, Anthracite grey RAL 7016, automatic plug-and-play bollards in stainless steel

D-ribbed

The silky-smooth surface finish emphasises the high-end quality of the D-ribbing. This door style, together with the Hörmann aluminium entrance door ThermoSafe 872, creates a harmonious matching appearance for your doors.



→ Available in the Silkgrain surface. Further information can be found starting on pages 34 and 58.





AUTOMATIC PLUG-AND-PLAY BOLLARD.

Automatic bollards are suitable for securing entrances to residential buildings. The ready-to-install, electro-mechanical plug-and-play bollard is particularly quick and easy to install. It also has an integrated BiSecur radio receiver and can be conveniently controlled remotely via hand transmitter or optionally with the BlueSecur app.





S-panelled

The embossed panelled style emphasises your home's classic charm. Harmoniously-integrated glazings give the door its distinct appearance and let natural light flood into the garage.

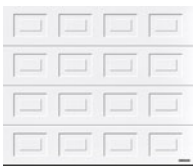

→ Available in the Woodgrain surface. Further information can be found starting on pages 28 and 58.





TOP LEFT. S-panelled, Woodgrain, Traffic white
RAL 9016

TOP RIGHT. S-panelled, Woodgrain, Slate grey
RAL 7015

BOTTOM. S-panelled, Woodgrain, Moss green
RAL 6005 with glazing S2 in sandwich design



NEW. Slategrain surface finish

The embossed slate structure of the surface finish gives the door a modern appearance in line with current design trends. Choose your personal door design from five matt fine structure colours.

→ Available as L-ribbed and M-ribbed.

For all colours and details, see from page 61.

TOP LEFT. Detail Slategrain, Anthracite grey matt fine structure RAL 7016

TOP RIGHT. M-ribbed, Slategrain, Anthracite grey matt fine structure RAL 7016

BOTTOM LEFT. M-ribbed, Slategrain, Traffic white matt fine structure RAL 9016

BOTTOM RIGHT. L-ribbed, Slategrain White aluminium matt fine structure RAL 9007

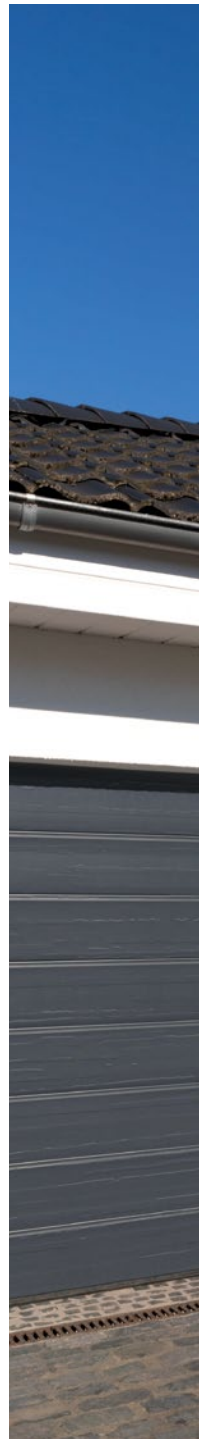



TOP LEFT. L-ribbed, Plainrain Anthracite grey matt fine structure RAL 7016

TOP RIGHT. **NEW.** L-ribbed, Plainrain Anthracite grey matt fine structure RAL 7016, Hörmann aluminium entrance door ThermoSafe style 860 with design handle 850, Plainrain Anthracite grey matt fine structure RAL 7016

BOTTOM. M-ribbed, Plainrain Grey aluminium matt fine structure RAL 9007





Plaingrain

Coordinated surfaces and colours for garage doors, entrance doors, side doors and steel doors



NEW. Plaingrain surface

The new surface in a modern, matt finish impresses with visually and tactilely coordinated sectional garage doors, aluminium and steel/aluminium entrance doors. Choose your personal door view from five matt fine structure colours.

→ Available as L-ribbed and M-ribbed. All colours and details can be found from page 61.



Woodgrain surface finish

On this inexpensive and robust surface finish with an authentic sawn timber look, minor scratches can be easily repaired.

→ Available as L-ribbed, M-ribbed, S-ribbed and S-panel.
For all colours and details, see from page 62.

TOP LEFT. Detail view of Woodgrain,
Traffic white RAL 9016

TOP CENTRE. M-ribbed, Woodgrain,
Traffic white RAL 9016

TOP RIGHT. L-ribbed, Woodgrain,
Anthracite grey RAL 7016

BOTTOM. M-ribbed, Woodgrain,
Window grey RAL 7040







Silkgrain surface finish

Thanks to its elegant door appearance, this silky smooth surface finish is the first choice for modern architecture. A 50% thicker exterior sheet on the sections also ensures higher stability and even smoother running.

→ Available as L-ribbed, M-ribbed and D-ribbed.
For all colours and details, see from page 62.





TOP LEFT. Detail view of Silkgrain, Anthracite grey RAL 7016

TOP CENTRE. L-ribbed, Silkgrain, Anthracite grey RAL 7016

TOP RIGHT. M-ribbed, Silkgrain, Traffic white RAL 9016

BOTTOM. D-ribbed, Silkgrain, Window grey RAL 7040



Door and garage door in a matching look

Design your home in beautiful colour harmony - with the new Plaingrain surface in five matt fine structure preferred colours or the 15 MatchColor preferred colours for the Woodgrain and Silkgrain surfaces. Thanks to the carefully curated colours, you can enjoy a harmonious overall appearance across matching sectional garage doors, aluminium and steel entrance doors and side entrance doors.

→ Further information can be found starting on page 61.



LEFT. L-ribbed Silkgrain design style 461, Quartz grey RAL 7039 with glazing elements; Hörmann ThermoSafe aluminium entrance door style 173, Quartz grey RAL 7039

TOP RIGHT. **NEW.** L-ribbed Plaingrain Anthracite grey matt fine structure RAL 7016; Hörmann steel / aluminium entrance door Thermo65 style 650 S Plaingrain Anthracite grey matt fine structure RAL 7016

BOTTOM RIGHT. M-ribbed, Silkgrain, Window grey RAL 7040; Hörmann aluminium entrance door ThermoSafe style 860, Window grey RAL 7040

Decograin surface finish

The detailed surface finish is available in five natural-looking timber designs and with an Anthracite metallic effect. Your door remains beautiful for a long time thanks to the special surface protection with UV-resistant plastic film coating on the outside of the steel sections.

→ Available as L-ribbed and M-ribbed.
All decors and details can be found from page 64.

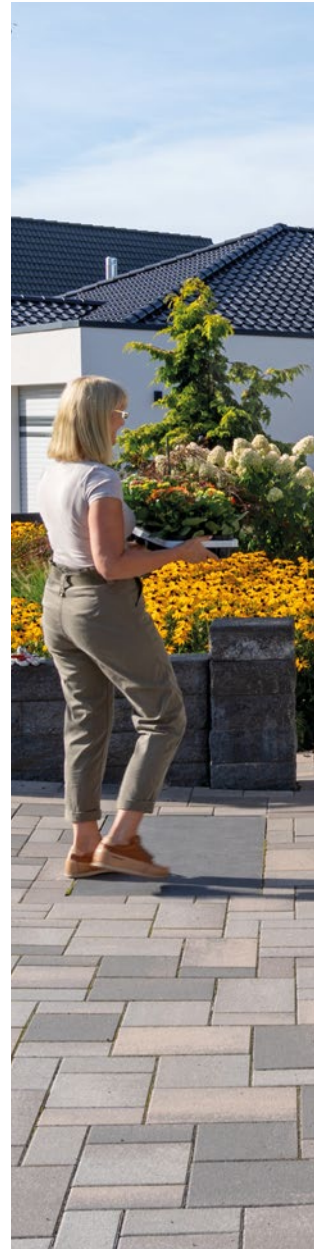
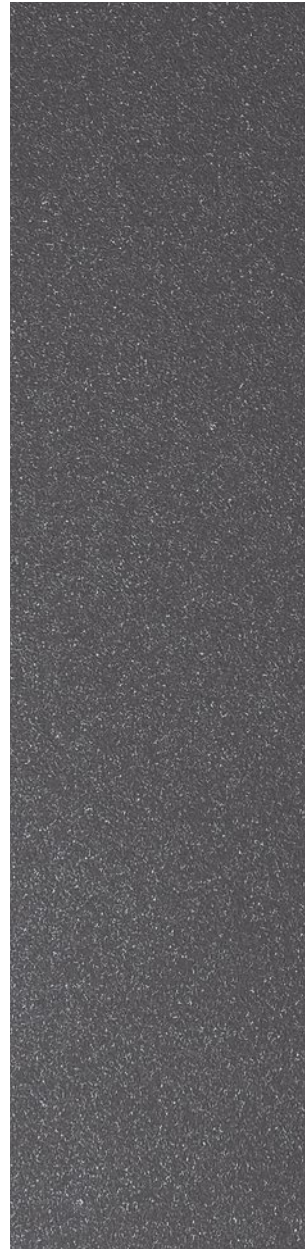



TOP LEFT. Detail view of Decograin Titan Metallic CH 703

TOP RIGHT. M-ribbed, Decograin Titan Metallic CH 703

BOTTOM LEFT. Detail view of Decograin Golden Oak

BOTTOM CENTRE. L-ribbed, Decograin Golden Oak

BOTTOM RIGHT. M-ribbed Decograin Dark Oak



Duragrain surface finish

With this smooth door surface, you can choose from detailed, natural and true-colour decors or, if you wish, have your door printed with an individual image. The high-quality coating of high-strength protective paint is especially robust, scratch-resistant and stain-resistant. As a result, your door maintains its attractive look. The garage door is available in combination with the Hörmann aluminium entrance door ThermoSafe MatchDecor in four decors for a matching look. Thus, entrance and garage door form a harmonious unit – simply beautiful!

→ Available as L-ribbed. All decors and details can be found from page 64.

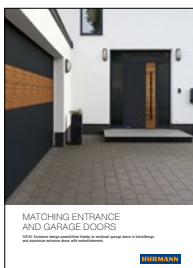
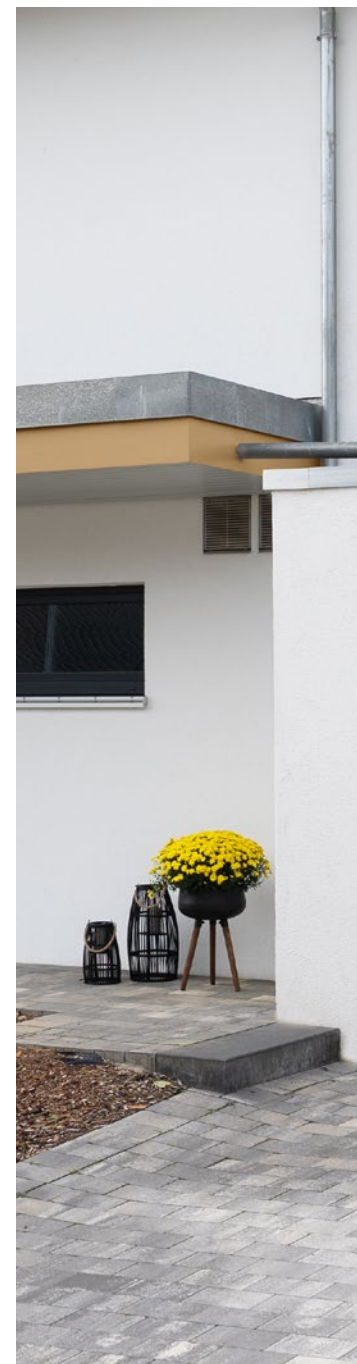

For further information, see the "Entrance door and garage door with a matching look" brochure.



For further information, see the "Duragrain surface finish" brochure.



TOP LEFT. L-ribbed, Duragrain concrete with matching appearance side door

TOP CENTRE. L-ribbed, Duragrain individual print

TOP RIGHT. Old wooden hinged door

BOTTOM. L-ribbed, Duragrain Malt Oak vertical design



Glazed doors

ALUMINIUM FRAME DOOR ART 42 / ART 42 THERMO.

This door version with standard profile or profile with thermal break convinces with more light in the garage or with better ventilation in the parking boxes of collective garages if grille infills are used.

→ Further information can be found starting on page 70.





TOP. ART 42 Vitraplan, grey tinted

LEFT. ART 42 Thermo with synthetic double panes, frame in Anthracite grey RAL 7016, Hörmann aluminium entrance door ThermoSafe style 650, Anthracite grey RAL 7016, optional side elements

ALUMINIUM FRAME DOOR ART 42 VITRAPLAN. The flush-fitting glazing in front of the ART 42 Vitraplan is particularly appealing with its clean and extremely elegant look. The frame profile in Jet black RAL 9005 is concealed so that the overall view is not compromised.

→ Further information can be found starting on page 70.





Facade doors / large doors

INDUSTRIAL SECTIONAL DOOR ALR F42 FOR ON-SITE

CLADDING FLUSH WITH THE FACADE. Design your sectional door according to your wishes with timber, metal, ceramics, plastic and many other materials. The door basis for facade cladding is a Hörmann industrial sectional door ALR F42 with an aluminium frame construction and PU sandwich infill.

INDUSTRIAL SECTIONAL DOOR ALR F42 VITRAPLAN AT.

The surface-mounted, flush-fitting facade panels are a real eye-catcher for private garages. Combined with the colour-matched, concealed frame profiles, the door has a captivating harmonious appearance.

INDUSTRIAL SECTIONAL DOOR SPU F42 PLUS. This door version is the ideal solution for garages up to 7000 mm wide and for special fitting situations where an operator cannot be fitted above the door.

→ You can find further information at <https://hbp.hoermann.com/uk/portal> or contact your Hörmann sales partner for advice.



TOP. ALR F42 with on-site, flush-fitting cladding

BOTTOM LEFT. ALR Vitraplan AT with façade panels in special colour

BOTTOM RIGHT. SPU F42 Plus M-ribbed, Silkgrain, Anthracite grey RAL 7016

Solid timber doors

These seven door styles made of untreated or brushed Nordic Pine are excellently suited for timber houses or buildings with many timber elements, such as timber framing or facade elements. Choose from five wood preservatives or three colour coatings.

→ Available in Nordic Pine. Further information can be found page 72 onwards.





LEFT. Door style 401, solid timber Nordic Pine, Glazed Larch

TOP RIGHT. Door style 405, high-quality coating in Traffic white RAL 9016 with hinged door fitting kits and decorative handles

BOTTOM RIGHT. M-ribbed, solid timber Nordic Pine, untreated



Hinged garage doors

EASY ACCESS. With the double-leaf hinged garage doors, you can either open both leaves or even just one leaf, in order to get your bike out of the garage, for example. Enjoy maximum comfort by equipping your hinged garage door with an operator. The thermally insulated sections provide good insulation and are available in all surface finishes.

→ Further information can be found starting on page 82.



CUSTOMISED LEAF DIVISION. Design your hinged garage door entirely to suit your needs. The door leaves are available in both symmetrical and asymmetrical division. The symmetrical division, with door leaves of equal width, offers a harmonious door appearance. In the asymmetrical division*, the traffic leaf comes in a width of 870 mm, which allows easy pedestrian passage into the garage. The width of the fixed leaf results from the total width of the door. Choose the traffic leaf on the left or right side of the door as you wish.

* Up to 2000 mm door width



Side doors

As an alternative entrance to your garage, Hörmann side doors are available in the same surface finishes, colours and decors as your garage door. If required, they can also come with exactly the same alignment of the ribbing. This ensures that everything fits together. If you value good thermal insulation and also want to reduce the risk of condensation forming on the inside, a multi-purpose door MZ Thermo with thermal break is the best choice for you.

→ Further information can be found starting on page 80.

Wicket doors

A wicket door in the garage door lets you easily access gardening tools, bikes or wheelbarrows in your garage. The stainless steel threshold of the wicket door is only 10 mm high in the centre and only 5 mm high at the edges. This reduces the risk of tripping and makes it easier to wheel things through.

→ Further information can be found starting on page 78.



TOP LEFT. L-ribbed, Silkgrain, Basalt grey RAL 7012 with matching side door

TOP RIGHT. M-ribbed, Woodgrain, Anthracite grey RAL 7016 with wicket door

BOTTOM. Single-leaf multi-purpose door MZ Thermo65, Traffic white RAL 9016



Intelligent accessories

You no longer have to go out in any wind and weather to check if your door is closed. At the press of a button, the colour of the LED on the hand transmitter HS 5 BS or the internal push button FIT 5 BS indicates the door position. If required, another push of a button* closes the door. Or use your smartphone as a door opener with the Hörmann BlueSecur app. It is the most convenient and secure way to control your door.

→ The accessories are available for all sectional garage doors.

* An additional photocell is required for operation without visual contact to the door.

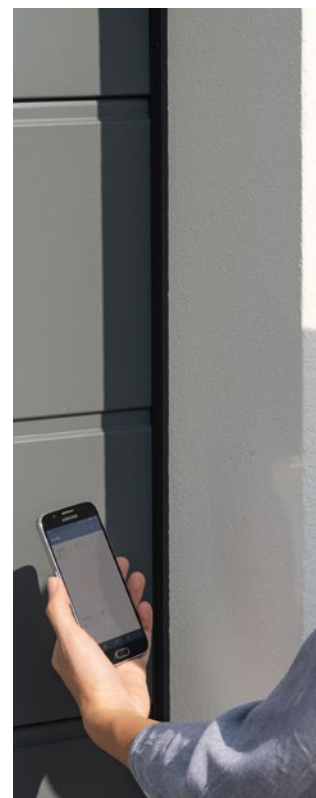

Light solutions

Alongside the bright operator light, the new LED strips create interior lighting as bright as day. So your garage is brightly lit with a clear, neutral white light no matter what time of day.



TOP LEFT. L-ribbed, Silkgrain, Anthracite grey RAL 7016, Hörmann aluminium entrance door ThermoSafe style 504 in Anthracite grey RAL 7016

TOP RIGHT. SupraMatic 4 garage door operator with bright operator light and additional LED strips

BOTTOM LEFT. Smart door operation with the Hörmann BlueSecur app

BOTTOM RIGHT. LED strips for fitting to the operator boom





Design Equipment Accessories

- 56 Steel sectional doors
- 60 Design elements and VarioDesign
- 61 Surface finishes
- 70 Aluminium frame doors
- 71 Glazings
- 72 Solid timber sectional doors
- 74 Equipment
- 78 Wicket doors
- 80 Side doors
- 82 Hinged garage doors
- 84 Operators
- 86 Accessories
- 88 Dimensions and technical manual

Steel sectional doors

Door leaf construction

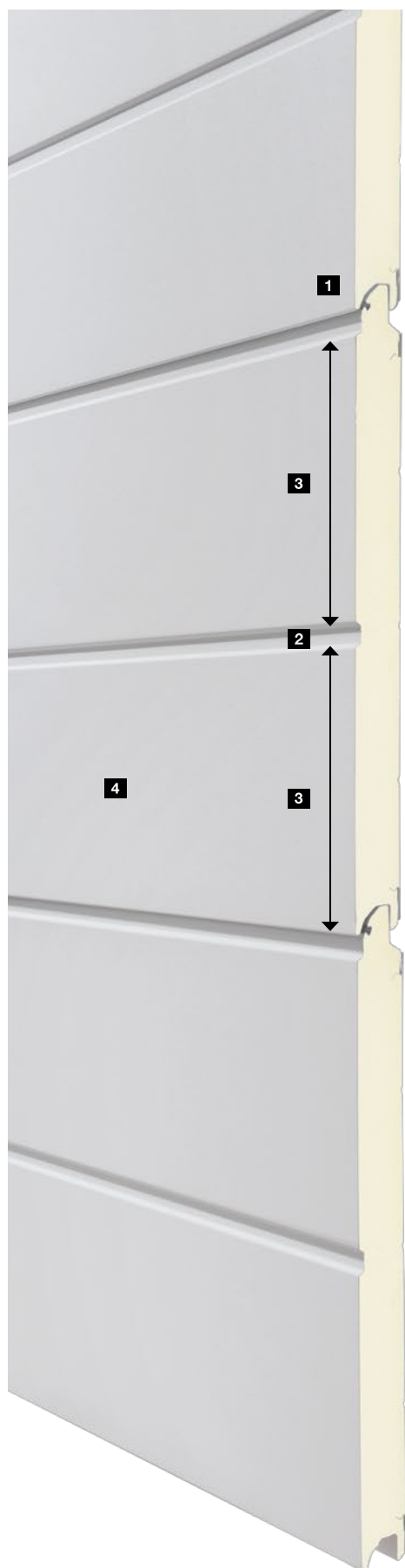

Only from Hörmann

Uniform bead spacing
at every door height

1 Section transition

The door leaf of a sectional door consists of several sections that are flexibly connected with a tongue-and-groove system. With Hörmann, the transitions are shaped so that they are practically invisible when the door is closed. See for yourself!

2 Ribbing

A ribbing is stamped into the exterior sheet of the section. It has the same view as a section transition.

3 Uniform spacings

For a particularly harmonious door appearance, Hörmann divides the ribbing and the section transitions evenly at every door height.

4 Permanently beautiful door appearance

On the outside, depending on the surface, the high-quality colour coating, the UV-resistant plastic film coating or the high-strength protective paint gives your door a permanently beautiful appearance.

Steel sectional doors

With maximum energy efficiency

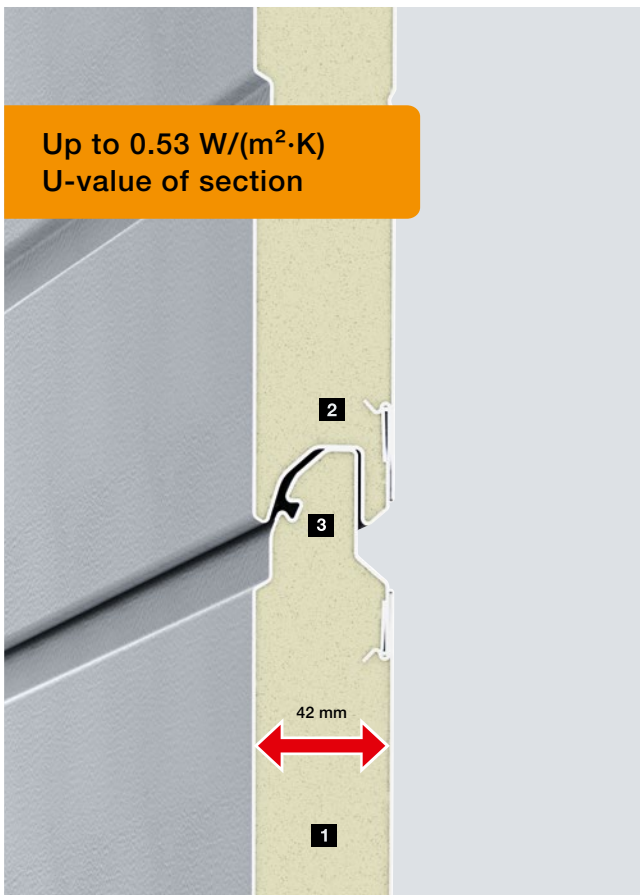

LPU 42

The bestseller
with good thermal insulation

- 42 mm thick sections **1**
- Supported sections **2** carry the door leaf weight
- Single lip seal in the section transitions **3**
- U-value of the door with ThermoFrame:
1.2 W/(m²·K)*
- Also available in Premium and PremiumPlus
versions (further information
can be found on page 76)

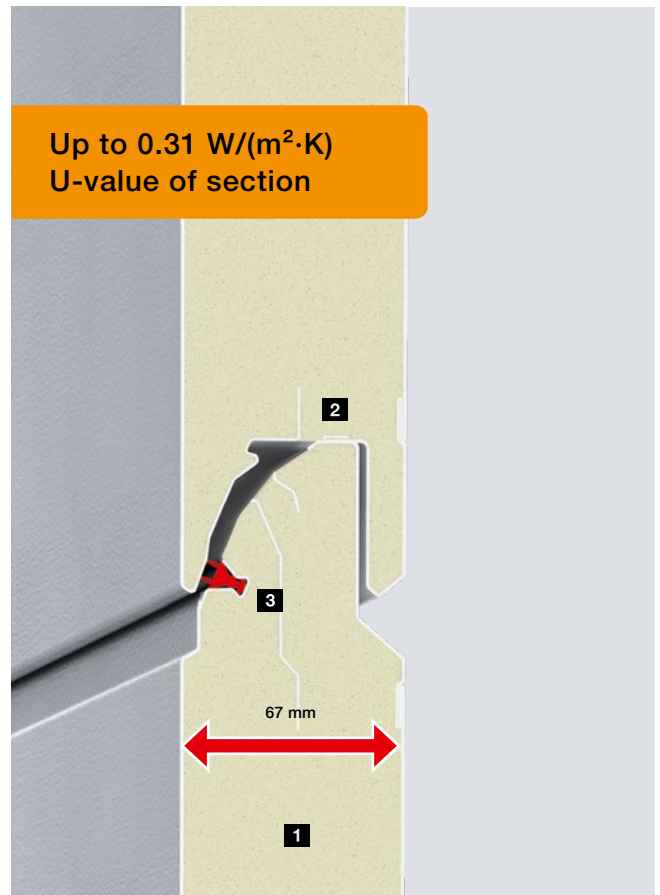

LPU 67 Thermo

The energy-saving door
with excellent thermal insulation

- 67 mm thick sections with thermal break **1**
- Supported sections **2** carry the door leaf weight
- Double lip seal in the section transitions **3**
- U-value of the door with ThermoFrame:
0.91 W/(m²·K)*
- Also available in Premium version
(further information can be found on page 76)

* The U-values apply to fitted doors without glazing with the dimensions 5000 × 2125 mm



The supra-fast operator SupraMatic 4 further reduces heat loss by opening the door at speeds of up to 28 cm/s. For further information, see page 84.

Steel sectional doors

Door styles LPU 42

L-ribbed

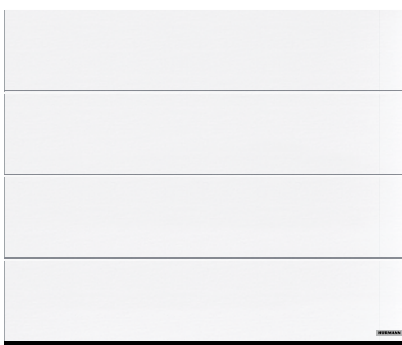

- NEW. Slategrain** 5 Matt fine structure preferred colours
- NEW. Plaingrain** 5 Matt fine structure preferred colours
- Woodgrain** Traffic white, 10 MatchColor and 5 preferred colours, RAL to choose
- Silkgrain** Traffic white, 10 MatchColor and 5 preferred colours, RAL to choose
- Decograin** 3 decors
- Duragrain** 37 decors, 6 vertical designs, 4 MatchDecors

M-ribbed



- NEW. Slategrain** 5 Matt fine structure preferred colours
- NEW. Plaingrain** 5 Matt fine structure preferred colours
- Woodgrain** Traffic white, 10 MatchColor and 5 preferred colours, RAL to choose
- Silkgrain** Traffic white, 10 MatchColor and 5 preferred colours, RAL to choose
- Decograin** 3 decors

S-ribbed



- Woodgrain** Traffic white, 10 MatchColor preferred colours and 5 Color preferred colours, RAL to choose

D-ribbed

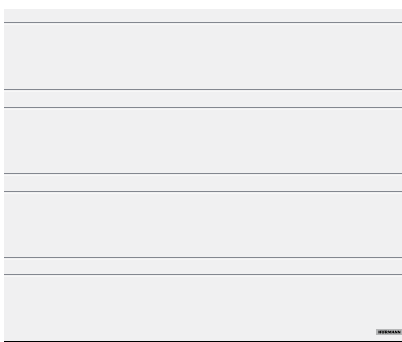

- Silkgrain** Traffic white, 10 MatchColor and 5 preferred colours, RAL to choose

S-panelled

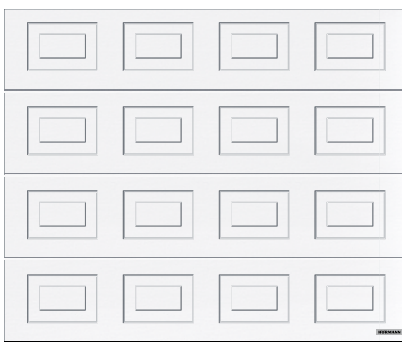

- Woodgrain** Traffic white, 10 MatchColor and 5 preferred colours, RAL to choose

Steel sectional doors

Door styles LPU 67 Thermo

L-ribbed

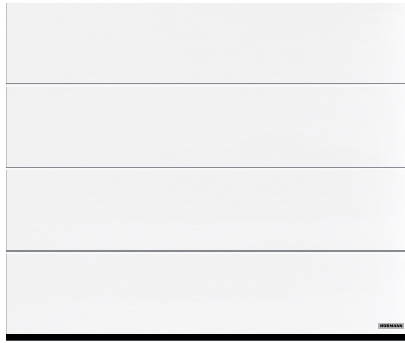

NEW. 5 Matt fine structure colours preferred colours

Plaingrain

Silkgrain Traffic white, 10 MatchColor and 5 preferred colours, RAL to choose

Decograin 3 decors

M-ribbed



Silkgrain Traffic white, 10 MatchColor and 5 preferred colours, RAL to choose

Decograin 3 decors

LPU 42

LPU 67 Thermo

Performance characteristics according to European standard 13241

	LPU 42	LPU 67 Thermo
Section material	Galvanized sheet steel with high-quality coating	Galvanized sheet steel with high-quality coating
Section thickness	Double-skinned, 42 mm	Double-skinned, 67 mm
Thermal insulation U-value fitted door	1.3 W/(m ² ·K) ¹⁾	1.0 W/(m ² ·K) ¹⁾
Acoustic insulation	Approx. 25 dB	Approx. 25 dB
Wind load ⁴⁾	Class 3	Class 3
Air / water tightness	Class 3 ³⁾ / Class 3 ²⁾	Class 3 ³⁾ / Class 3 ²⁾
Max. width	6000 mm	5000 mm
Max. height	3000 mm	3000 mm

¹⁾ The U-values apply to fitted doors without glazing with the dimensions 5000 × 2125 mm

²⁾ Up to 70 Pa water pressure

³⁾ Available for panelling and L-ribbing (LPU 42 doors with S-, M- or D-ribbing as well as with wicket door: class 2)

⁴⁾ Higher wind load classes on request

Design elements

For LPU 42 and LPU 67 Thermo

Styles with design elements

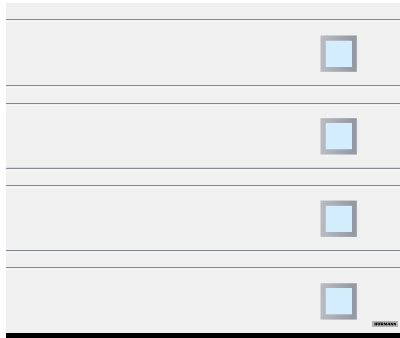

Design elements and glazing



Style 451

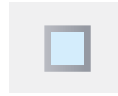

Style 461



Style 471



Style 481



Style 459



Style 469

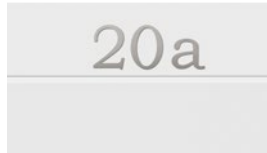

"Numbers and words"
Positive view, modern font

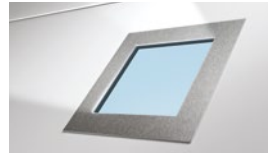

Design element in brushed stainless steel with optional real glass* for styles 461 and 481

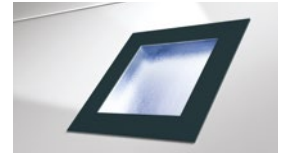

Design element painted in Anthracite grey RAL 7016 with synthetic glazing for styles 461, 462, 463, 469, 481, 482 and 483

VarioDesign styles

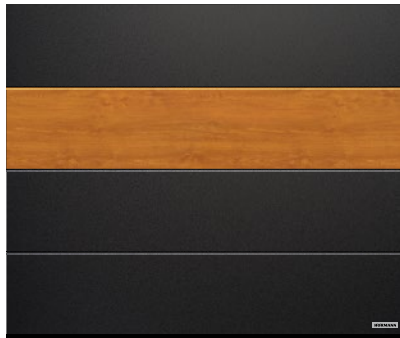

L-ribbed (LPU 42), Silkgrain, Anthracite Metallic CH 703, Decograin Golden Oak

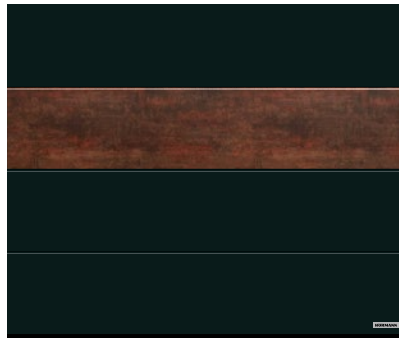

L-ribbed (LPU 42), Silkgrain Jet black RAL 9005, Duragrain Rusty Steel



L-ribbed (LPU 42), Silkgrain, Stone grey RAL 7030, Duragrain Barnwood grey

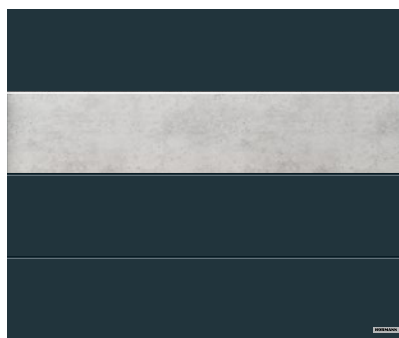

L-ribbed (LPU 42), Silkgrain, Anthracite grey RAL 7016, Duragrain concrete

VarioDesign

Create a unique accent by using different sections in the door leaf. With our VarioDesign, you can lend doors with the Woodgrain or Silkgrain surface finishes a special appearance with Duragrain or Decograin sections.

- For doors with up to 4 sections, one section may differ,
- For doors with up to 5 sections, 2 sections may differ,
- For doors with 6 sections 3 sections may differ
- Available for doors up to 5500 mm wide

→ Available for Woodgrain and Silkgrain surfaces.

Please note:

Not available for wicket doors

NEW. Slategrain



NEW. Plainrain

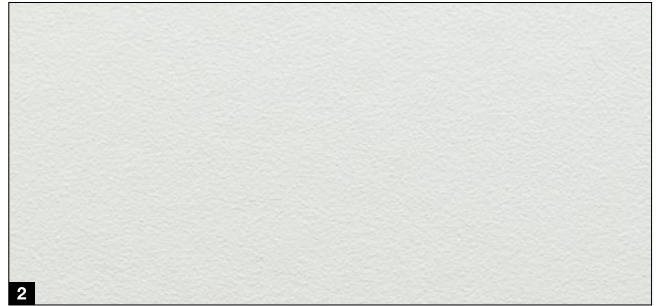

5 Matt fine structure preferred colours

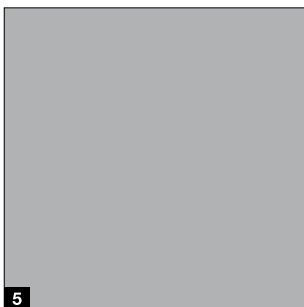
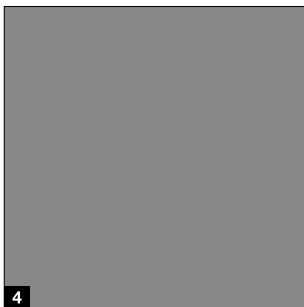
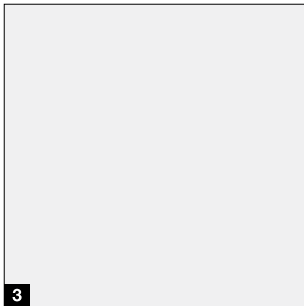

Plainrain

Coordinated surfaces and colours for garage doors, entrance doors, side doors and steel doors

Surface finishes

- 1 Slategrain
- 2 Plainrain

5 Matt fine structure preferred colours

- 3 RAL 9016 Traffic white
Matt fine structure
- 4 RAL 9007 Grey aluminium
Matt fine structure
- 5 RAL 9006 White aluminium
Matt fine structure
- 6 RAL 7016 Anthracite grey matt fine structure
- 7 CH 703 Anthracite metallic matt fine structure

Please note:

Sectional garage doors are generally supplied in Grey white RAL 9002 on the inside of the door. Dark colours should not be used for double-skinned steel doors that are exposed to the sun, as possible section deflection may damage the door.

All colours based on RAL. The colours and surface finishes shown are subject to the limitations of the printing process and cannot be regarded as binding.

Please consult with your local Hörmann sales partner.

Surface finishes

Woodgrain, Silkgrain

Woodgrain

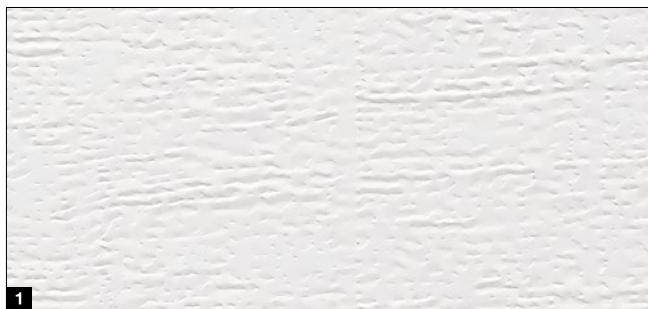

Silkgrain

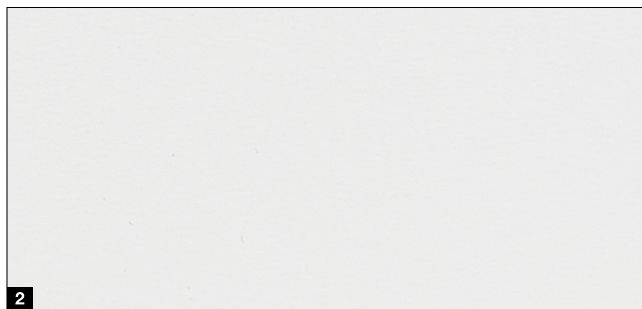

MatchColor, preferred colours

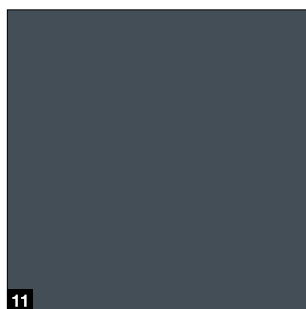
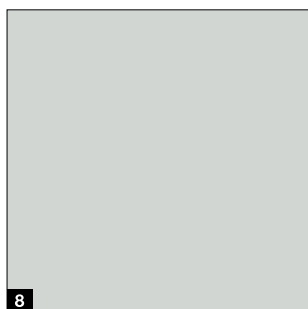
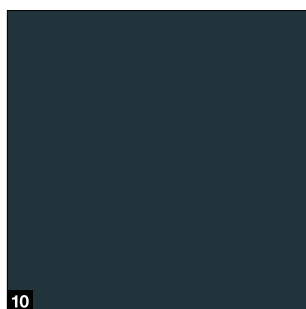
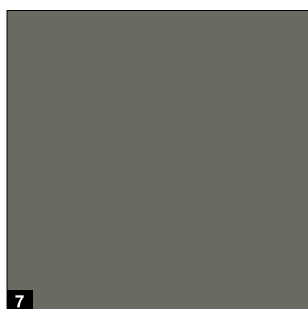
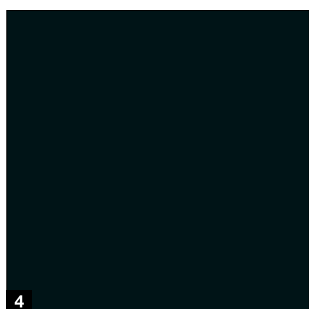
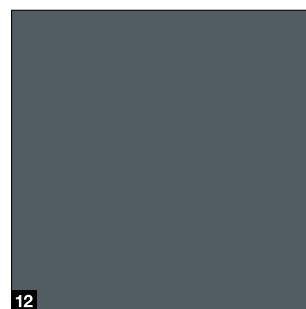
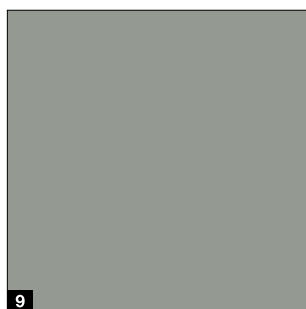
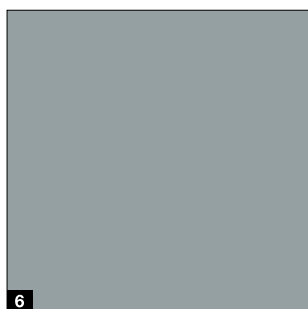
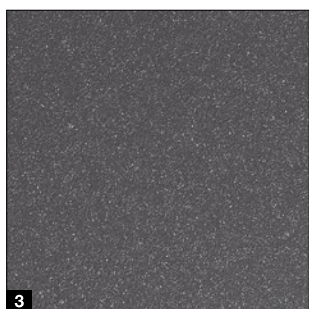

Please note:

In combination with the optional high-quality protective paint or "anti-graffiti" protective paint, all MatchColor preferred colours are available as a Color preferred colour for which a matching appearance of sectional garage doors, entrance doors, side doors and steel doors cannot be guaranteed.



MatchColor

Coordinated colours for garage doors,
entrance doors, side doors and steel doors

Surface finishes

- 1 Woodgrain RAL 9016 Traffic white
- 2 Silkgrain RAL 9016 Traffic white

MatchColor, preferred colours

- 3 CH 703-AM Anthracite Metallic
- 4 RAL 9005 Jet black
- 5 RAL 8028 Terra brown
- 6 RAL 7040 Window grey
- 7 RAL 7039 Quartz grey
- 8 RAL 7035 Light grey
- 9 RAL 7030 Stone grey
- 10 RAL 7016 Anthracite grey
- 11 RAL 7015 Slate grey
- 12 RAL 7012 Basalt grey

Preferred colours

- 13 RAL 9007 Grey aluminium
- 14 RAL 9006 White aluminium
- 15 RAL 6009 Fir green
- 16 RAL 6005 Moss green
- 17 RAL 1015 Light ivory

RAL to choose

The Woodgrain and Silkgrain surfaces are optionally available in around 200 RAL Classic colours (excluding pearl effect and fluorescent colours) as well as in many NCS and DB colours.

Preferred colours

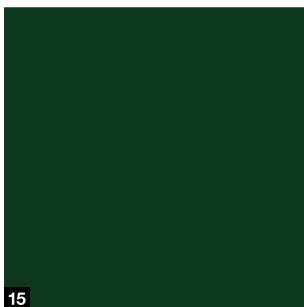
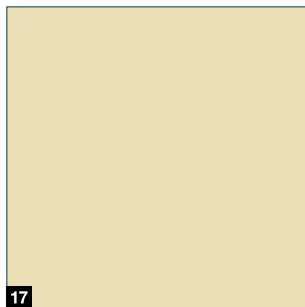
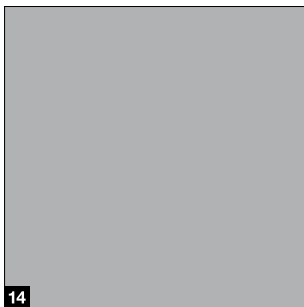
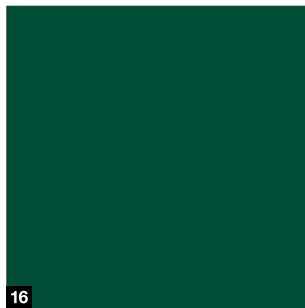
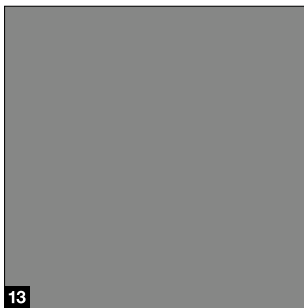

Please note:

Sectional garage doors are generally supplied in Grey white RAL 9002 on the inside of the door. Dark colours should not be used for double-skinned steel doors that are exposed to the sun, as possible section deflection may damage the door. All colours based on RAL. The colours and surface finishes shown are subject to the limitations of the printing process and cannot be regarded as binding.

Please consult with your local Hörmann sales partner.

Surface finishes

Decograin, Duragrain

Decograin

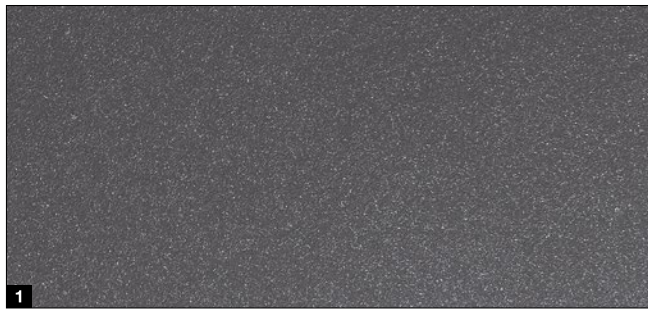

Decograin decors

- 1 Titan Metallic CH 703: Anthracite with a metallic effect
- 2 Golden Oak: Medium brown, golden yellow oak decor
- 3 Dark Oak: Walnut-coloured oak decor

Please note:

Sectional garage doors are generally supplied in Grey white RAL 9002 on the inside of the door. Dark colours should not be used for double-skinned steel doors that are exposed to the sun, as possible section deflection may damage the door.

All colours based on RAL. The colours and surface finishes shown are subject to the limitations of the printing process and cannot be regarded as binding.

Please consult with your local Hörmann sales partner.

Duragrain



Rusty Steel decor door appearance

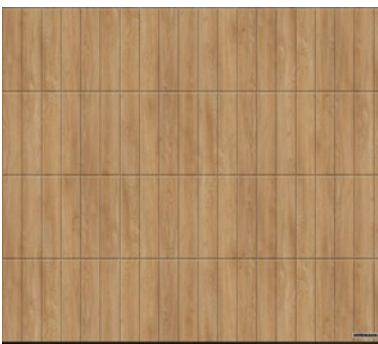

Malt Oak vertical design door appearance



MatchDecor Barnwood door appearance

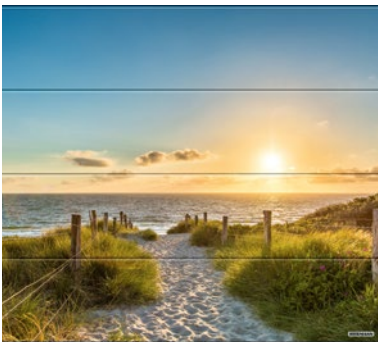

Style image door appearance



Duragrain

Extremely scratch-resistant

Scratch-resistant and stain-resistant

The innovative digital printing process, in combination with the high-strength protective paint, ensures that your door will look good for years to come.



- 1 Double-skinned section
- 2 Galvanisation
- 3 Primer coating
- 4 Innovative digital print
- 5 High-strength protective paint



For further information, see the "Duragrain surface finish" brochure.

Surface

Duragrain

Decors

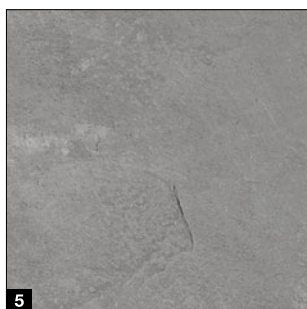
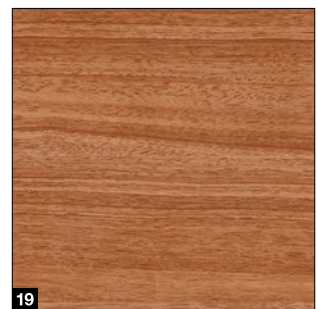
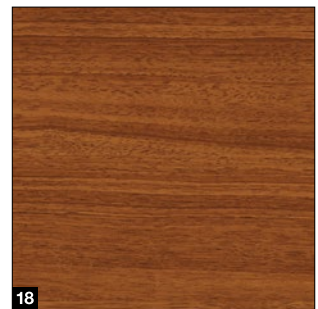
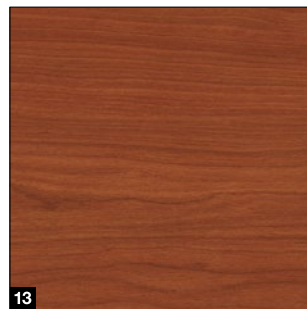
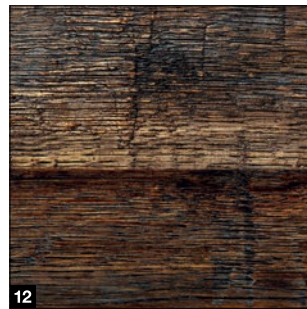
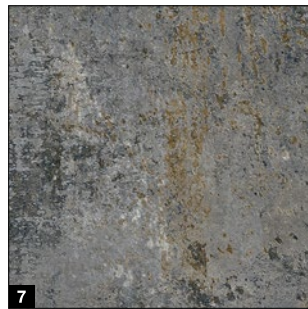
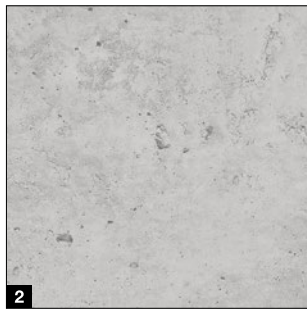
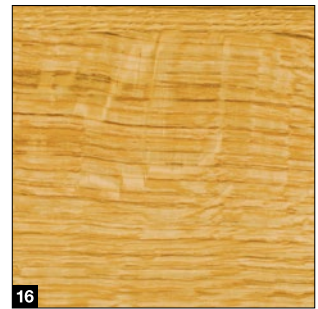
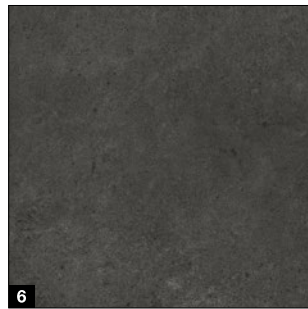

MatchDecor



21



26

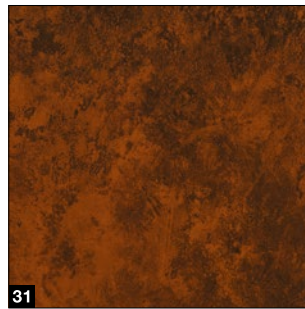

31

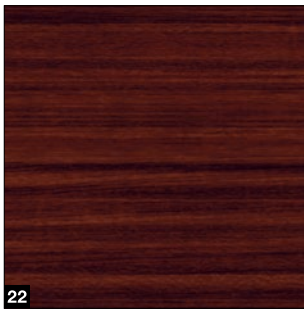

22



27

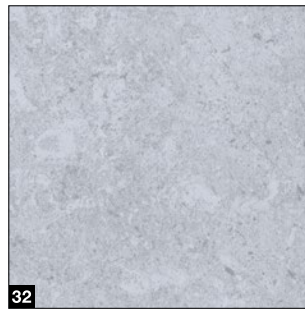

32



23



28



33



24



29

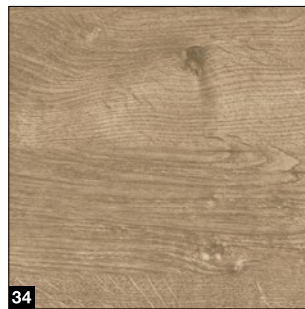

34



25



30

Decors

- 1 Beige
- 2 Concrete
- 3 **NEW.** Concrete Surface
- 4 Corten Steel
- 5 Grigio
- 6 Grigio scuro
- 7 **NEW.** Grunge Wall
- 8 **NEW.** Limestone
- 9 Moca
- 10 Rusty Steel
- 11 **NEW.** Antique Parket
- 12 Burned Oak
- 13 Cherry
- 14 Spruce
- 15 Malt Oak
- 16 Nature Oak
- 17 **NEW.** Night Oak
- 18 Noce sorrento balsamico
- 19 Noce sorrento natur
- 20 **NEW.** Rosewood
- 21 Rusty Oak
- 22 Sapeli
- 23 Sheffield
- 24 Barnwood grey
- 25 Teak
- 26 Toffee Oak
- 27 Colonial Walnut
- 28 Terra Walnut
- 29 **NEW.** Winchester Oak
- 30 Whitewashed Oak*



MatchDecor
Coordinated decors
for garage doors and
entrance doors

MatchDecor

- 31 Rusty Patina
- 32 Cement
- 33 Barnwood
- 34 Wild Oak

* Also available in the
Vertical design

→ All 47 decors can be found in the Duragrain surface brochure.

Surface protection

For a long and beautiful door appearance

High-quality coating

The sections are optimally protected by the double-sided hot-galvanized sheet steel in conjunction with the high-quality coating in Grey white RAL 9002 on the inside. For even better protection, you can also get the exterior of the sections with an optional high-quality protective paint or with all-round protection as the PremiumPlus version (for more information, see page 76). The high-quality Duragrain surface finish is offered with high-quality protective paint as standard.

Protective paints for a long and beautiful door appearance

High-quality protective paint

The surface finish of the sections is especially robust, scratch-resistant and stain-resistant thanks to the protective paint.

High-quality protective paint "anti-graffiti"

Due to the protective paint on the surface of the section as well as on glazings, design elements, etc., graffiti can be removed with a commercially available special cleaner.

→ Available for Woodgrain and Silkgrain surfaces.



- 1 Double-skinned section
- 2 Galvanisation
- 3 High-quality coating
- 4 Optional: high-quality protective paint or high-quality "anti-graffiti" protective paint

Tested by Hörmann: Cleaning and maintenance set for a beautiful, long-lasting door

Using the wrong cleaning equipment can often cause discolouration or leave unsightly scratches. With the cleaning and maintenance set, you're always on the safe side. The set has been developed together with Sonax, the market leader for cleaning and maintenance products for vehicle surfaces, and all components have been tested by Hörmann for use on steel garage doors as well as steel and aluminium entrance doors. It not only makes cleaning much easier but also reduces the risk of damaging the garage doors.

→ Watch the short film on YouTube or www.hormann.co.uk/media-centre

Matching appearance

For door leaf and frame

Only from Hörmann

Door leaf, fascia panel and side frames matching in Woodgrain Traffic white RAL 9016

Matching appearance of door frame and door leaf

The harmonious appearance of a door is the result of many small details: The fascia panel **1** provided always matches the door sections for all surface finishes. This ensures that everything fits together. The side frames **2** are available with a white Woodgrain surface finish as standard. With frame coverings **3**, the side frames can be easily adapted to the surface finish of the sections.

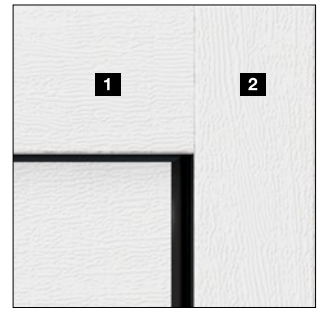

	Woodgrain	NEW. Slategrain	Silkgrain, NEW. Plaingrain	Decograin, Duragrain
Fascia panel 1	●	●	●	●
Side frame 2	●	■	■	■
Frame covering 3	●	○	●	●

- = Identical surface, colour or decor same as door section
- = Woodgrain surface finish in Traffic white RAL 9016 (in Grey white RAL 9002 for the Premium version)
- = Smooth surface, colour like the door section



Aluminium frame doors

ART 42 / ART 42 Thermo / ART 42 Vitraplan

Section view

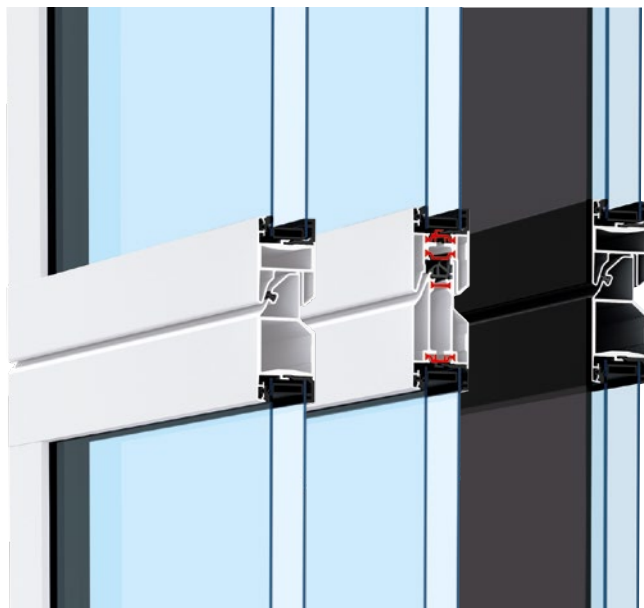

ART 42

ART 42 Thermo

ART 42 Vitraplan

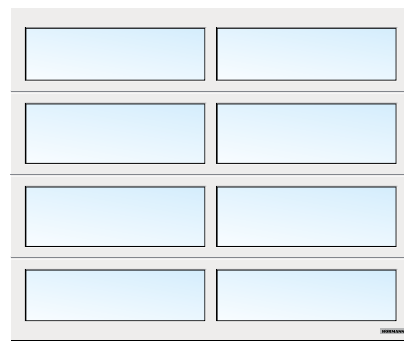

ART 42 glazed, Traffic white RAL 9016

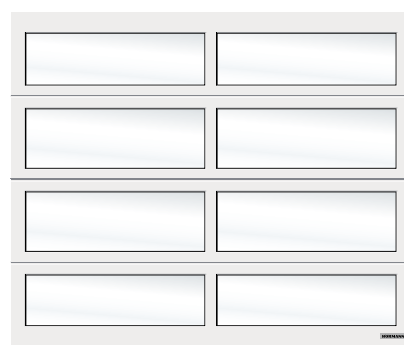

ART 42 glazed white tinted, Traffic white RAL 9016

ART 42 / ART 42 Thermo / ART 42 Vitraplan

Frame material	aluminium
Frame thickness	42 mm
Thermal insulation ART 42 U-value fitted door	4.0 W/(m ² ·K) ¹⁾
Thermal insulation ART 42 Thermo U-value fitted door	3.4 W/(m ² ·K) ¹⁾
Acoustic insulation	R = approx. 20 dB
Wind load ³⁾	Class 3
Air / water tightness	Class 2 ²⁾ / Class 3 ²⁾
Max. width	4000 mm
Max. height	3000 mm
Colours	Traffic white, 10 MatchColor and 5 preferred colours, RAL to choose

¹⁾ U-values apply to fitted doors with synthetic double pane S2 with the dimensions 5000 × 2125 mm

²⁾ Doors with ventilation slots, classes 2 – 3 on request

³⁾ Higher wind load classes on request

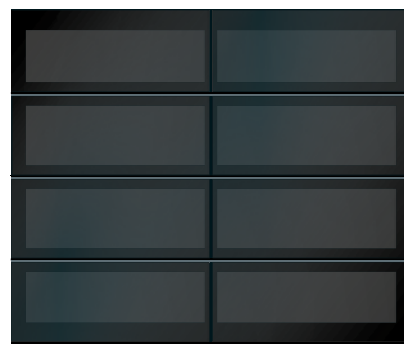

ART 42 Vitraplan, grey tinted

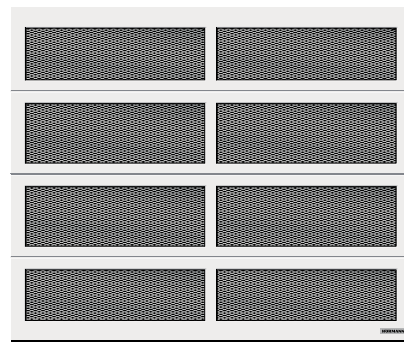

ART 42 with expanded mesh, Traffic white RAL 9016

Glazing variants



1



2



3



4



5



6



7



8



9



10



11



Duratec
Synthetic glazing
with maximum scratch
resistance

Glazing variants for LPU 42 and LPU 67 Thermo

- 1 Glazing S0¹⁾
- 2 Glazing S1
- 3 Glazing S2
- 4 Glazing SOE²⁾
- 5 Glazing MO¹⁾
- 6 Glazing MOE²⁾
- 7 Glazing LO¹⁾
- 8 Glazing LOE²⁾
- 9 Glazing type D¹⁾
- 10 Aluminium light strip³⁾
- 11 Narrow aluminium light strip

Infill variations

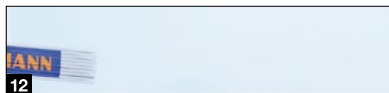

12



13



14



15

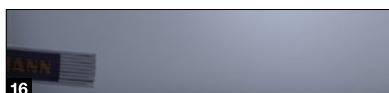

16



17

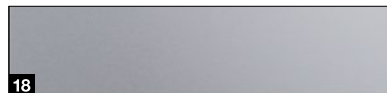

18



19



20



21

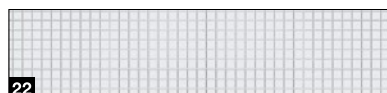

22



23

Infill variants for LPU 42, LPU 67 Thermo, ART 42 and ART 42 Thermo

- 12 Polycarbonate double pane, clear / synthetic double pane, clear
- 13 Synthetic double pane, white tinted (opal / clear)
- 14 Synthetic double pane, crystal structure
- 15 Multiple-moulded pane
- 16 Synthetic double pane, grey tinted
- 17 Black glass⁴⁾
- 18 PU sandwich infill, smooth
- 19 PU sandwich infill, stucco
- 20 Perforated stainless steel sheet
- 21 Stainless steel expanded mesh
- 22 Crimped mesh
- 23 Welded grille

¹⁾ Individual arrangement of glazing possible

²⁾ Not available for LPU 67 Thermo

³⁾ Rails possible

⁴⁾ Only for glazing SOE, MOE, LOE

Solid timber sectional doors

LTH 42



Standard styles

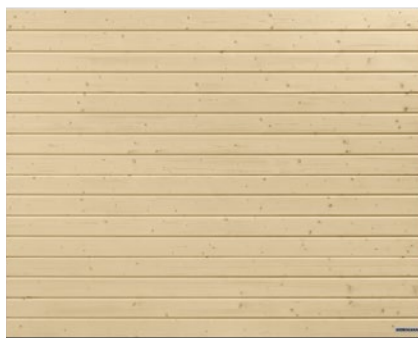

S-ribbed



M-ribbed



L-ribbed



Panelled



Reinforcement at section ends

Design styles



Style 401



Style 402

LTH 42

Section material	Solid timber
Section thickness	42 mm
Thermal insulation U-value ¹⁾	2.9 W/(m ² ·K)
Wind load class ³⁾	3
Tightness class ²⁾ air / water tightness	0 / 0
Max. width	5000 mm
Max. height	3000 mm

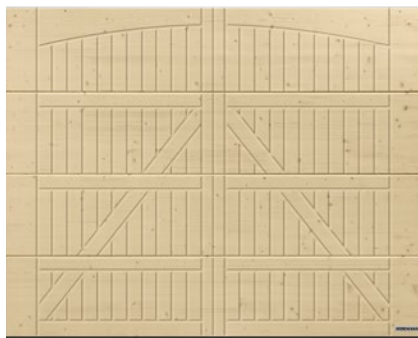

Style 405



Style 405, with optional hinged door fitting kits "Exclusive"

¹⁾ The U-values apply to fitted doors without glazing with the dimensions 5000 × 2125 mm

²⁾ Doors with ventilation slots, classes 2 – 3 on request

³⁾ Higher wind load classes on request

Types of timber

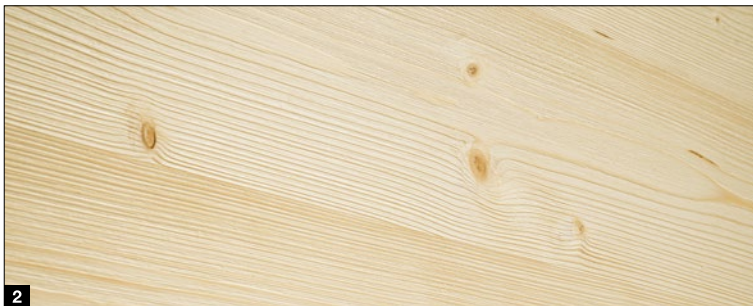

Types of timber

- 1 Nordic Pine, untreated
- 2 Nordic Pine, brushed

High-quality wood preservatives

- 3 Pine
- 4 Larch
- 5 Walnut
- 6 Sand beige
- 7 Silver

High-quality coatings

- 8 RAL 9016 Traffic white
- 9 RAL 9001 Cream
- 10 RAL 7035 Light grey

High-quality wood preservatives

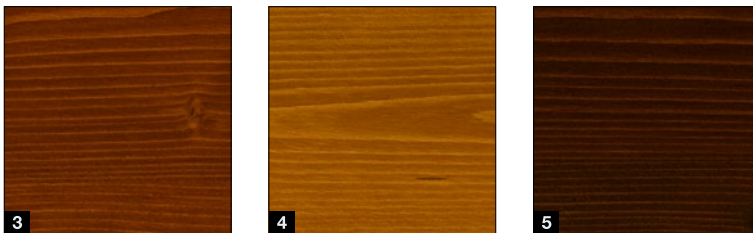

High-quality coatings

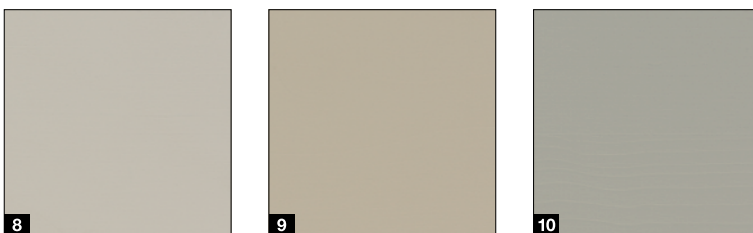

Please note:

Timber is a natural product. The durability depends on many factors such as type of weathering, constructive wood protection, mechanical load and the choice of colour. Timely maintenance work is required to achieve durability, therefore annual maintenance is recommended. Do not use dark glazes in direct sunlight. Keep the garage well ventilated.

All colours based on RAL. The colours and surface finishes shown are subject to the limitations of the printing process and cannot be regarded as binding.

Please consult with your local Hörmann sales partner.

Standard equipment

For a secure and long-lasting door function

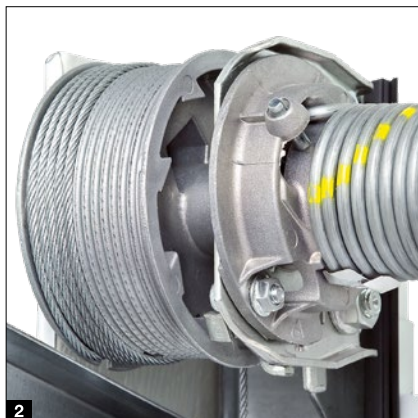

Tension spring technology with multi-spring system ¹

Up to 4000 mm door width and 2600 mm door height

The system reliably secures the door leaf against falling and prevents a broken spring from flinging away and injuring people.

Torsion spring assembly with integrated spring safety device ²

From 4000 mm door width or 2600 mm door height as well as for doors with wicket door and for solid timber doors

The spring safety device stops door travel immediately in the event of a spring break and the door leaf does not lintel.

Secure door guide in safety tracks ³

Adjustable rollers, stable roller holders and safety tracks prevent derailment. The door leaf is safely parked under the ceiling.

Finger trap protection ⁴

On the inside, outside and on the hinges

The unique shape of the door sections eliminates trap points, both between the sections and on the hinges.

Trap guard on the side frames ⁵

With Hörmann, the frames are completely closed from top to bottom. There are no gaps between the door leaf and frame in which fingers could get trapped!

Only from Hörmann
European patent

Plastic frame shoe ⁶

A non-brittle, 4 cm plastic frame shoe covers the frame where it is prone to rusting and offers long-term protection against corrosion, even with waterlogging, which is unmatched by competitor solutions. Together with the door's bottom seal, the frame shoe makes for a bottom edge that is visually appealing.



Optional equipment

For greater convenience and safety

Premium version

For LPU 42 ¹, LPU 67 Thermo ², ART 42 and ART 42 Thermo: For a beautiful interior view, the fittings, frames, tracks and the connection rail are painted matching the inside of the section in Grey white RAL 9002 ¹. Twin rollers ensure very quiet and gentle door travel.

PremiumPlus version

For LPU 42: In addition to the Premium version, the all-round protection to minimize corrosion in maritime climates offers a section with final coating on the exterior and painted cut edges as well as ribbing infill profiles for better sealing on the section transitions and in the section area (for S-, M- and D-ribbing).

High-quality inside paintwork

For LPU 42 with Woodgrain or Silkgrain surface finish: For a uniform door appearance inside and out, you can optionally have the inside of the door in the same surface finish / colour as the outside. Choose from the Basic variant ³ with high-quality coating of the inside section **A** or the Comfort variant ⁴ with additional colour-matching of the end brackets **B**, door leaf reinforcements **C**, glazing frames and ventilation grilles.

Ventilation slot on the topmost section ⁵

For LPU 67 Thermo ² and LPU 42 ² with operator SupraMatic or ProMatic (from year of manufacture 2012): With the optional folding roller bracket, you only open the top section of your door to ventilate the garage. The bottom door section remains sealed on the ground, thus offering protection against small animals or leaves.

Emergency release lock ⁶

For LPU 42 and LTH 42: You can use an emergency release lock to manually unlock your garage from the outside in an emergency. An inconspicuous round cylinder (cannot be integrated into the master key system) is connected to the emergency / maintenance release of the operator boom on the inside.

Door handle for emergency / maintenance release ⁷

For all door versions: The door handle is equipped with a lock that can be integrated into the master key system. Use the handle to unlock the emergency / maintenance release of the operator boom via a Bowden cable on the inside of the door. The door handles are available in the following versions: Black plastic, White cast aluminium, RAL 9016 and brushed stainless steel (see Fig.).

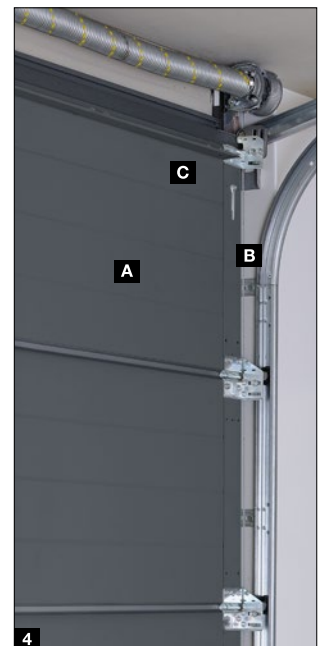

ThermoFrame ⁸

For all door versions: The plastic profile can be easily fitted together with the door frame, creating a thermal break between the frame and brickwork, thus improving thermal insulation by up to 15%³⁾. In addition, extra sealing lips on both sides and in the upper section of the door lower the loss of heating energy from the garage interior.

- ¹⁾ Galvanized spring assembly incl. holder, spring safety device, cable drum, operator boom
- ²⁾ Only track application N, L, Z, not possible for doors with wicket door
- ³⁾ For a double-skinned sectional garage door LPU 42 with the dimensions 5000 × 2125 mm



RC2 security features

For LPU 42, LPU 67 Thermo: The certified RC2 security features make your door even safer and are recommended by police information centres.

→ Watch the video on YouTube or www.hormann.co.uk/media-centre

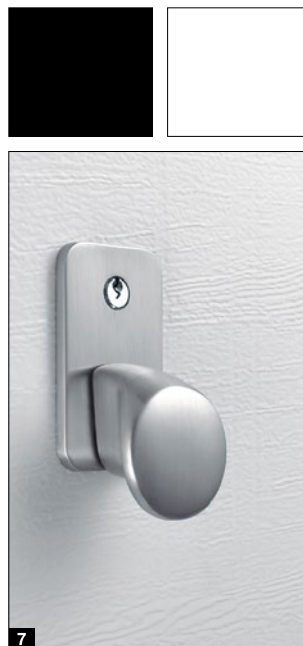

Wicket doors

With trip-free threshold

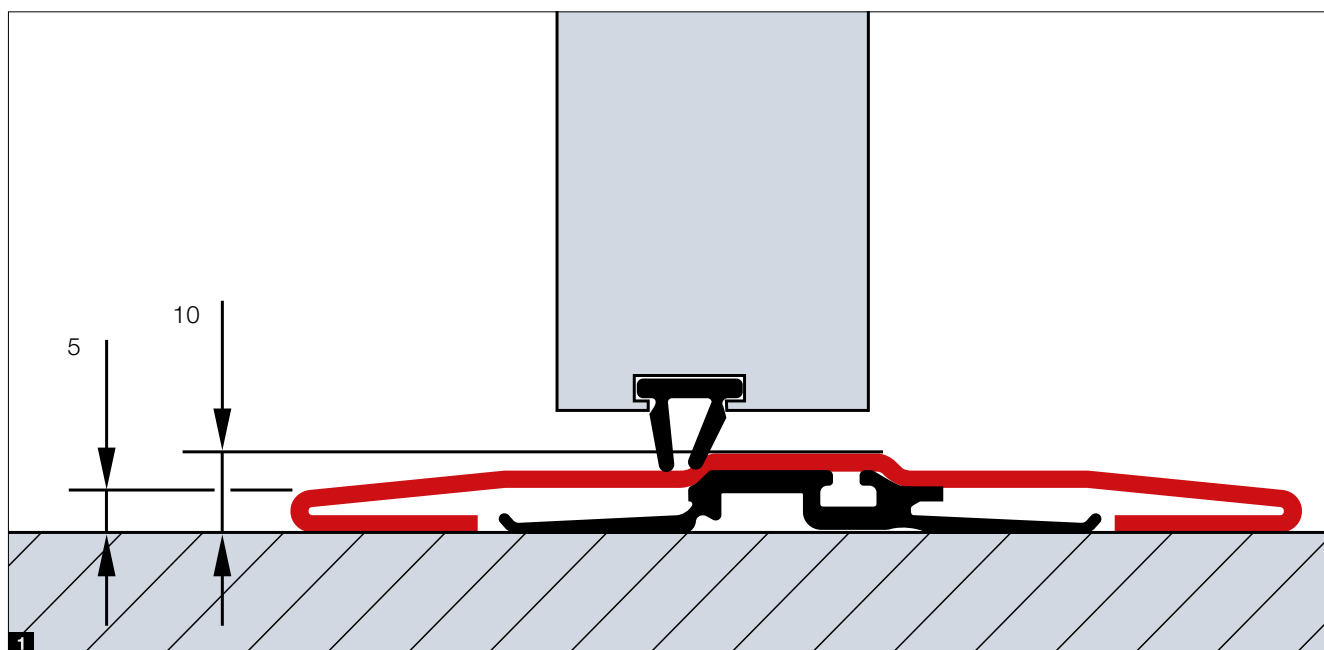

Door versions

- LPU 42 with track application N (up to 5 m door width)
- LPU 42 with track application Z (up to 4 m door width)
- LPU 42 with track application L (up to 5 m door width)

Clear opening widths

- Width 830 mm
- Width 1140 mm

Stainless steel threshold **1**

- Reduces the risk of tripping and makes it easier to wheel things through
- Height at centre only 10 mm and at edge only 5 mm

Standard equipment

- Aluminium door frame in anodised natural finish **2**
- Sturdy hold-open device prevents door leaf dropping and warping **3**
- Concealed hinges for a uniform door view **4**
- Slide rail door closer incl. integrated opening limiter and hold-open device **5**

Optional equipment

- Aluminium door frame in RAL to choose (also different from the door colour) or painted to match the colour of the decor (Decograin, Duragrain surface finishes)
- Integrated door closer incl. hold-open device for optimum protection and the best appearance **6**
- Multiple-point locking with one bolt and hook bolt per section for better stability and improved break-in resistance **7**
- Leading photocell VL 2 stops the door without contact and increases safety **8**
- Push bar in black / green, for escape door, inside (anti-panic lock required) **9**

Please note:

In some cases, adjacent panelled doors with the same width, with or without wicket door, may not have a uniform panel spacing. Manually operated garage doors with wicket door do not have an exterior door handle. They are locked from the inside.

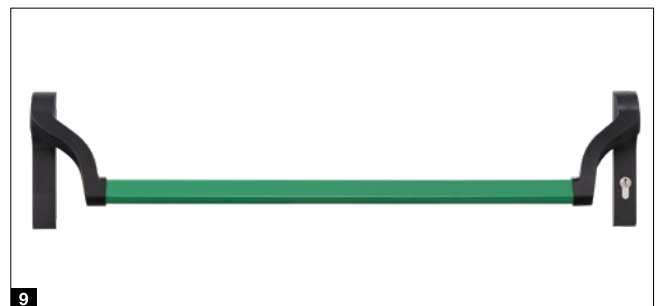

Side doors

NT 60 / NT 80

Door sizes

- Width (single-leaf) 875 – 1330 mm
- Width (double-leaf) 1331 – 3000 mm
- Height (single- / double-leaf) 1800 – 2558 mm

Leaf frames

- Wide version (profile type 2)

Standard equipment

- 60 mm thick weather-resistant aluminium profiles in the colour of the sections **1**
- Traffic leaf with black plastic lever handle set with oval rose escutcheons and profile cylinder lock **2**
- 3-way adjustable hinges optionally in black, white or aluminium natural finish **3**
- Fixed bolt for locking the fixed leaf with double-leaf side doors **4**

Optional equipment

- Concealed hinges for an elegant door view in the version with aluminium block frame **5**
- Break-in-resistant RC2 security features with 3-point-locking (latch, bolt, 2 locking hooks) and security rose escutcheon **6**
- Double-leaf side doors with asymmetric division (traffic leaf always 870 mm wide in a size range of 1330 – 2000 mm RAMB)
- Mechanical hold-open device for traffic and fixed leaf **7** for fixing the door leaves in open position to the floor
- Mechanical hold-open device **8** for holding the door leaves and hold-open devices at any desired position, with pull bell to release the hold-open devices
- Lever handle or lever / knob handle sets in aluminium natural finish **9**, brushed stainless steel **10**, cast aluminium RAL 9016 **11** and black cast aluminium **12**





Insulated version NT 80

- Aluminium profile system, frame and threshold with thermal break
- 80 mm depth



Multi-purpose door MZ Thermo

- Door leaf and frame with thermal break
- Excellent thermal insulation value of 1.2 W/(m²·K).
- Optionally in RC2 version (KSI Thermo)

Hinged garage doors

DFT 42

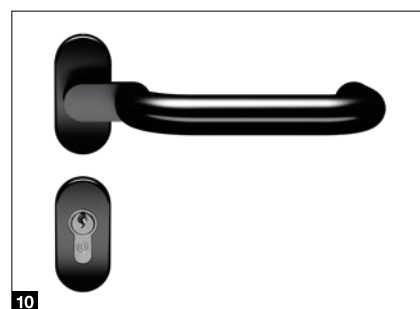
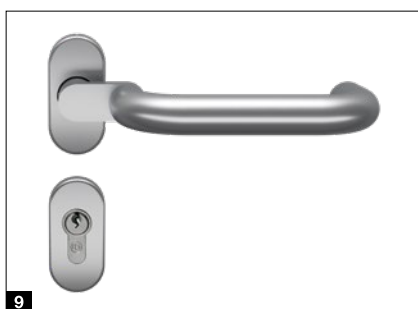
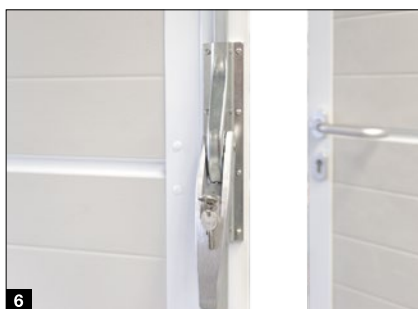

Door sizes

- Width 1330 – 3000 mm
- Height 1960 – 2500 mm

Standard equipment

- Door infill made of 42 mm thick sections **1**
- For S-ribbed, M-ribbed, L-ribbed and D-ribbed in all colours and decors
- 60 mm thick aluminium frame profiles in section colour **2**
- 3 sturdy hinges per door leaf (one hinge secured) in aluminium colour **3**
- 3-sided double door seal and double lip seal in the threshold area **4**
- Traffic leaf with aluminium lever handle set and profile cylinder lock **5**
- Fixed leaf with door espagnolette lock **6**

Optional equipment

- Mechanical hold-open device **7** for traffic and fixed leaf for fixing the leaves in open position to the floor
- Mechanical hold-open device with braking and damping function to prevent the leaves from uncontrolled slamming and opening and fixing in any desired position **8**
- Concealed hinges for an elegant door appearance
- Offset lever handle or lever / knob handle sets in aluminium natural finish **9** and black cast aluminium **10**

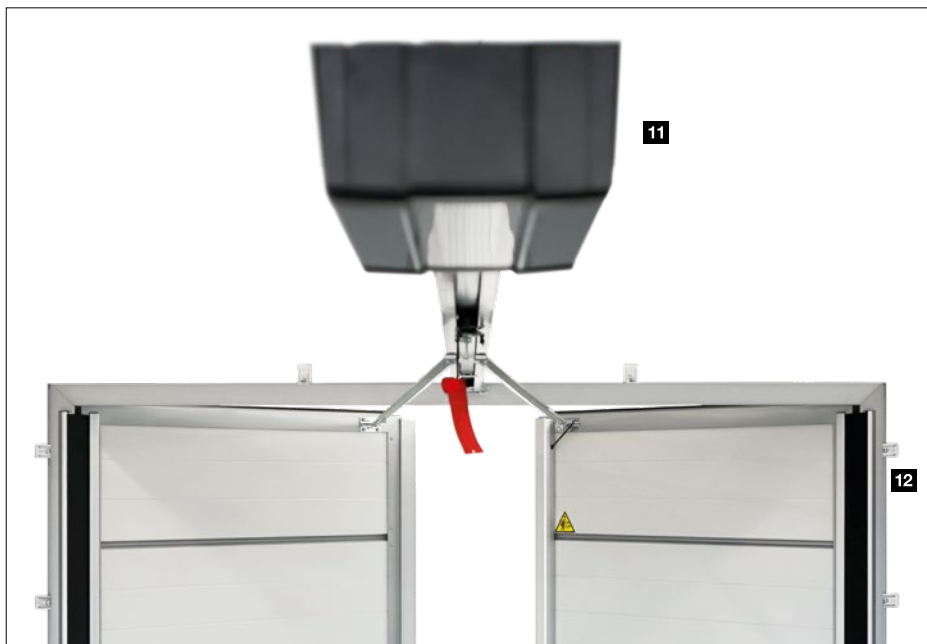

Operator equipment

- Hinged door fitting kit incl. cover for operators ProMatic 4 or SupraMatic 4 **11**
- Concealed hinges
- Finger guard or trap guard for an excellent safety inside **12**

Operators

SupraMatic 4

Supra-fast door opening and smart additional functions

- 75% faster opening speed* up to 28 cm/s resulting in reduced heat loss
- Smart operation with the BlueSecur app
- Convenient garage ventilation
- Additional opening height
- Up to 3 times (SupraMatic E) or 5 times* (SupraMatic P) brighter LED lighting
- Easy-to-use programming thanks to double 7-segment display
- High-quality operator cover in stainless steel design
- Networked with Smart Home systems via the standard HCP interface



BiSecur

As standard with two 4-button hand transmitters HSE 4 BS, textured surface black with chrome caps

Garage door operators	SupraMatic E	SupraMatic P
Bluetooth receiver	Integrated, can be switched on and off	Integrated, can be switched on and off
HCP bus connection	Integrated	Integrated
Cycles per day / hour	25 / 10	50 / 10
Pull and push force	650 N	750 N
Peak force	800 N	1000 N
Max. opening speed	25 cm/s	28 cm/s
Lighting	20 LEDs	30 LED chase light
Max. door width	5500 mm	6000 mm
Max. door surface	13.75 m ²	15 m ²

* In comparison with the ProMatic series 3

Only from Hörmann
European patent

Hörmann BlueSecur

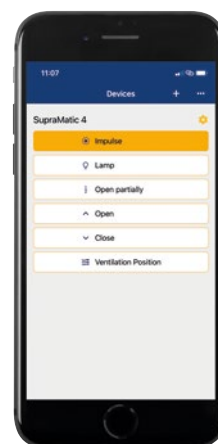

Operation by smartphone using the Hörmann BlueSecur app

Premium quality at an attractive price

- 40% faster opening speed* up to 20 cm/s
- Convenient garage ventilation
- Additional opening height
- Up to 2 times* brighter LED lighting
- Networked with Smart Home systems via the standard HCP interface

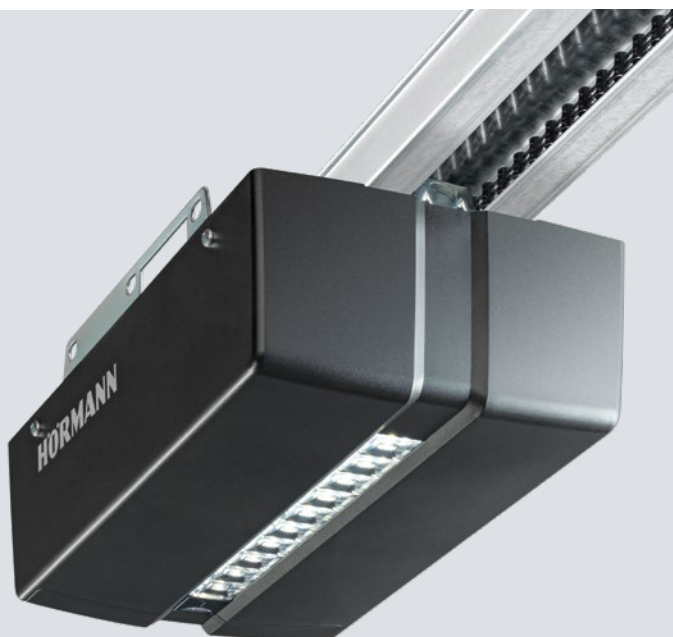

 **BiSecur**

As standard with two 4-button hand transmitters HSE 4 BS, black textured surface with plastic caps as standard

Garage door operators	ProMatic 4	ProMatic 4 Akku
Bluetooth receiver	Optional (HET-BLE)	Optional (HET-BLE)
HCP bus connection	Integrated	Integrated
Cycles per day / hour	25 / 10	5 / 2
Pull and push force	650 N	500 N
Peak force	800 N	600 N
Max. opening speed	20 cm/s	16 cm/s
Lighting	10 LEDs	10 LEDs
Max. door width	5500 mm	4000 mm
Max. door surface	13.75 m ²	9 m ²

ProMatic 4 Akku

For garages without power connection



Akku with solar module

* In comparison with the ProMatic series 3

Accessories

Hand transmitter



HS 5 BS
4 button functions plus query button, high-gloss surface black or white



HS 5 BS
4 button functions, plus query button, textured surface matt black



HS 4 BS
4 button functions, textured surface matt black



HS 1 BS
1 button function, textured surface matt black



HSE 1 BS
1 button function, including eyelet for key ring, textured surface matt black



HSZ 4 BS
4 button functions, incl. eyelet for key ring, textured surface matt black with chrome or plastic caps



HSE 4 BS
4 button functions, incl. eyelet for key ring
High-gloss finish with chrome caps,
Colours (pictured from left): White, anthracite grey, Frozen Grey, **NEW**. Rose gold, Carbon, Silver



HSD 2-C BS
High-gloss chrome, 2 button functions, can also be used as a key ring



HSZ 1 BS / HSZ 2 BS
1 or 2 button functions, for insertion in vehicle cigarette lighter



HSI 3 BS
To control up to 3 doors, with extra-large buttons, impact-resistant housing, protection category: IP 65



HSI 6 BS
To control up to 6 doors, with extra-large buttons, impact-resistant housing, protection category: IP 65



**Radio code switch
FCT 3 BS**

3 functions, with illuminated buttons, recessed or surface-mounted fitting possible, plastic housing in Light grey RAL 7040 (also available with 10 functions and hinged cover, painted in White aluminium RAL 9006)



**Radio code switch
FCT 10 BS**

10 functions, with illuminated buttons and hinged cover, recessed or surface-mounted fitting possible, plastic housing painted in RAL 9006 White aluminium



**Radio finger-scan
FFL 25 BS**

2 functions and up to 25 fingerprints, with hinged cover, recessed and surface-mounted fitting possible, plastic housing painted in RAL 9006 White aluminium



**Radio internal push button
FIT 5 BS**

4 button functions plus query button, plastic housing in Pure white RAL 9010

Button



**Radio internal push button
FIT 2-1 BS**

2 functions, connection option for max. 2 control elements via cable, e.g. key switch, plastic housing in Pure white RAL 9010



**Internal push button
IT 1b-1**

Large, illuminated button for convenient opening of the door, plastic housing in Pure white RAL 9010



**Transponder key switch
TTR 1000-1**

1 function, 1000 teachable keys, scope of delivery: 1 key and 1 card (more on request), zinc die-cast housing in White aluminium RAL 9006



**Code switch
CTP 3-1**

3 functions, with illuminated lettering and touch-sensitive black surface, zinc die-cast housing in White aluminium RAL 9006



**Code switch
CTV 3-1**

3 functions, particularly robust with metal keypad, zinc die-cast housing in White aluminium RAL 9006 with stainless steel panel



**Finger-scan
FL 150**

2 functions, control via fingerprint, up to 150 savable fingerprints, zinc die-cast housing in White aluminium RAL 9006 with stainless steel panel



**Key switch
1 STUP 50
2 STAP 50**

Recessed version and surface-mounted version, incl. 3 keys, zinc die-cast housing in White aluminium RAL 9006 with stainless steel panel



**Internal climate sensor HKSI 3
External sensor HKSA 4**

For monitoring humidity and automatic ventilation of the garage, plastic housing in Pure white RAL 9010

For measuring outdoor humidity, plastic housing in Pure white RAL 9010

Vertical views (with operator)

Track application Z

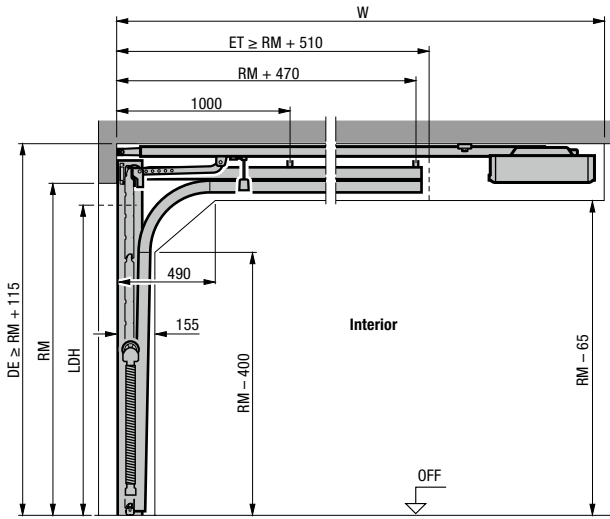

Track application N

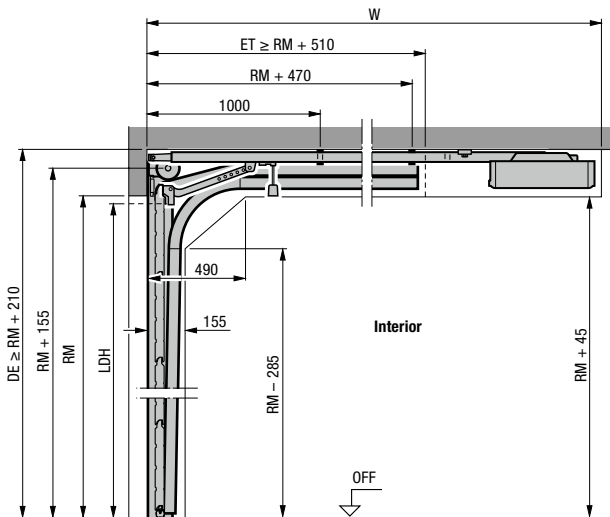

Track application L

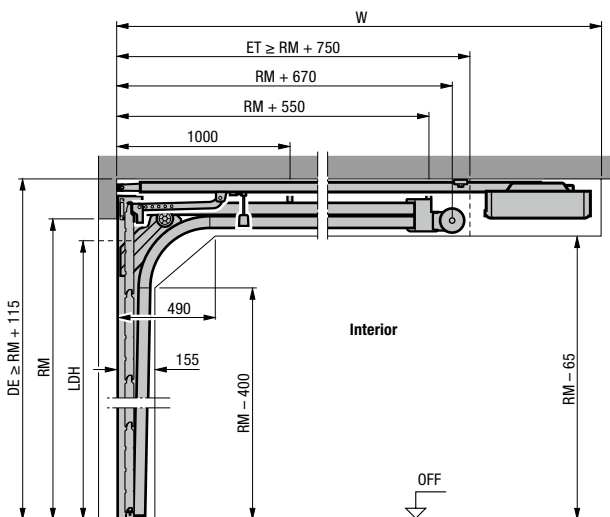

Horizontal view

Track application Z, N, L

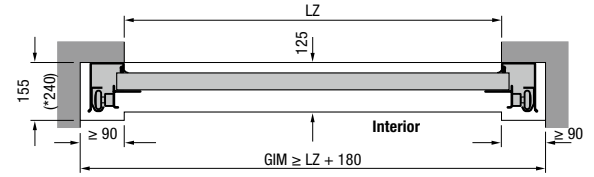

Fitting with track application Z, N, L

Overall length with operator (W)	Track application Z	Track application N	Track application L
Doors with operator			
2125 (K)	3200	3200 ¹⁾	3200
2250 (K)		3200 ²⁾	
Max. door height			
2375 (M)	3450	3450 ¹⁾	3450
2500 (M)		3450 ²⁾	
2600 (L)	4125		
3000 (L)		4125	4125

¹⁾ Max. door height only for LPU 67 Thermo

²⁾ Max. door height only for LPU 42

Explanations

Operator booms

- K Short boom
- M Medium boom
- L Long boom

Ordering sizes

- LZ Clear
- RM Grid height
- DE Ceiling height
- W Overall length with operator
- LDH Clear passage height
- GIM Inside garage dimension
- ET Distance back

Note:

The operator should be fitted 40 mm higher for dark coloured doors exposed to the sun.

Please note the deviating dimensions in the technical manual for doors LPU 42 with RC2 security features, door leaf weights of over 170 kg or door widths of over 5000 mm and for doors LPU 67.

For track applications such as high-lift track applications as well as further information, please see the technical manual or contact your Hörmann partner.

Dimensions and technical manual

Side doors

Horizontal views

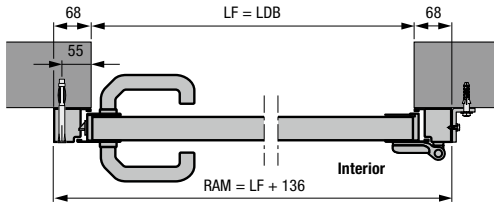

Side door with aluminium block frame, profile type 2
Fitting behind the opening

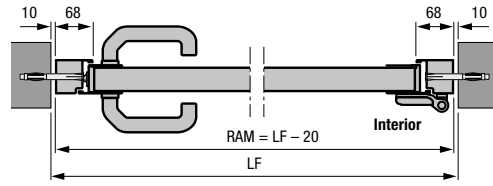

Side door with aluminium block frame, profile type 2
Fitting in the opening

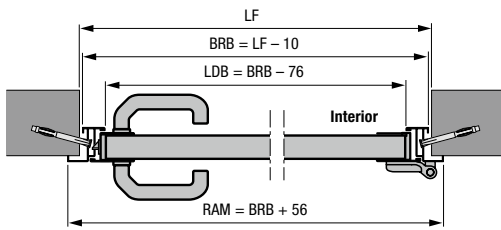

Side door with aluminium corner frame, profile type 2
Internal fitting

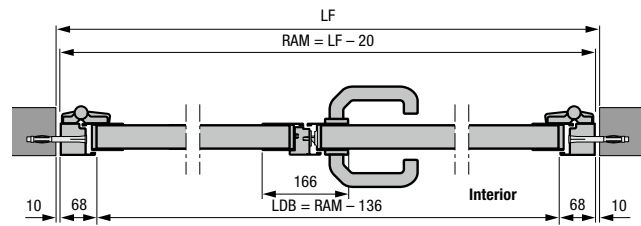

Double-leaf side door with aluminium block frame, profile type 2
Fitting in the opening

- Double-leaf side door with asymmetrical division
- Double-leaf side door opening inwards and outwards

Vertical views

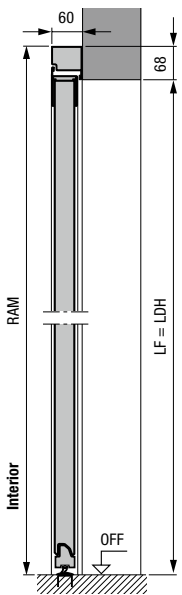

Side door with aluminium block frame, profile type 2
Fitting behind the opening

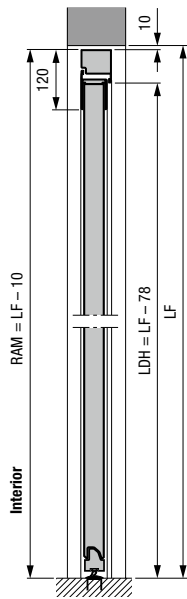

Side door with aluminium block frame, profile type 2
Fitting in the opening

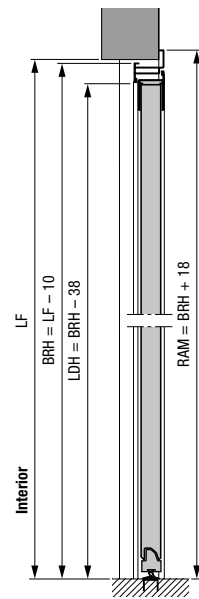

Side door with aluminium corner frame, profile type 2
External fitting

Dimensions in mm

Steel side doors

Profile type 2 (fitting behind the opening) with S-, M-, L-, D-ribbing, S-panelled, block frame

LF of the opening	Ordering size = RAM	Lever height* from OFF	Door section height B
855 – 875 × 1990 – 2000	990 × 2058	1050	500
855 – 875 × 2115 – 2125	990 × 2183	1050	531
980 – 1000 × 1990 – 2000	1115 × 2058	1050	500
980 – 1000 × 2115 – 2125	1115 × 2183	1050	531

Profile type 2 (fitting in the opening) with S-, M-, L-, D-ribbing, block frame

LF of the opening	Ordering size = RAM	Lever height* from OFF	Door section height B
875 × 2000	855 × 1990	1050	500
875 × 2125	855 × 2115	1050	531
1000 × 2000	980 × 1990	1050	500
1000 × 2125	980 × 2115	1050	531

Profile type 2 (internal or external fitting) with S-, M-, L-, D-ribbing, corner frame

Ordering size = BRM	Lever height* from OFF	Door section height B
875 × 2000	1050	500
875 × 2125	1050	531
1000 × 2000	1050	500
1000 × 2125	1050	531

Explanations

LDB	Clear passage width
LDH	Clear passage height
RAM	Overall frame dimension
LF	Structural opening
BRM	Nominal size
BRB	Nominal size width
BRH	Nominal height
OFF	Finished floor level (FFL)

Special sizes

Single-leaf side doors: on request

Double-leaf side doors:
1330 – 2500 × 1960 – 2558 mm

* You can find the lever heights for special sizes in the technical manual.

Hörmann. For Life.

Whether you are building your home or modernising it, you desire a place full of joy, security and relaxation. Thanks to their sustainable and particularly durable quality, Hörmann products will become a reliable part of your home – made to last for generations.

GARAGE DOORS. GATE AND DOOR OPERATORS. SMART HOME SYSTEMS. ENTRANCE DOORS. RESIDENTIAL INTERNAL DOORS. LOFT DOORS. STEEL DOORS. DOOR FRAMES. STORAGE SPACE SYSTEMS.



Some of the products shown feature special equipment and do not always correspond to the standard versions. The surface finishes and colours shown are subject to the limitations of the printing process and cannot be regarded as binding. All RAL colours are based on the RAL colour chart. All rights reserved. No part may be reproduced without our prior permission. Subject to changes.