

origin

DOORS AND WINDOWS

The Door Collection

Introducing the Origin Door Collection...

The Origin Home Collection is a suite of the finest quality products, designed and manufactured in Great Britain, by Origin

A fundamental part of this is the Door Collection which is a beautifully crafted and expertly executed collection of doors that are made from premium grade aluminium.

Offering two sightline options (either 49mm or 72mm), the Origin Door is available as a bi-fold, a corner bi-fold, a traditional French door or as a single door; meaning there's a door option for you, no matter your renovation.

In addition to being visually stunning, Origin Doors are completely bespoke, so you can tailor them to your stylistic and practical needs.

Complementing any property – whether it be a new or existing build, an extension, or even a period style cottage – the Door Collection is guaranteed to change the way a home is interacted with, enabling it to be enjoyed like never before, wherever you may be.

To some, a door is merely an entranceway to access a new area or room. But for Origin and tens of thousands of homes internationally, it's so much more. It's a transformation not only to the aesthetics of a home, but to a way of life; a lifestyle that unites surroundings and families alike.

The Door Collection holds the key to longer summer days, warmer winter evenings and an all year round uninterrupted widescreen view of your world.

Visually stunning, ultra-secure
and completely tailored to
your home



Product displayed: OB-49
Colour shown:
Jet Black - 9005M



Here at Origin, our vision is to *transform the way families enjoy their home – from inside to out*

Product displayed: OB-49 and OB-72
Colour shown: Hipca White - 9910G (OB-49)
and Anthracite Grey - 7016M (OB-72)



Product displayed: OB-49
Colour shown: Anthracite Grey - 7016M

The OB-49...

The OB-49 is our slimline door system that has been re-engineered from the industry-renowned OB-72. Its sightline of just 49mm means less profile and more glass is achieved, giving you a panoramic view of your surroundings.

Manufactured from premium grade aluminium, it offers impressive panel sizes without compromising on security, thermal or operational performance - it's the ultimate combination.



The OB-72...

The OB-72 is the door system that started it all for us. Born after our owners found they could not get great aluminium folding sliding doors for their building projects, their ambitious solution was to create a company capable of manufacturing the UK's best quality doors, that's backed by uncompromising levels of service.

The result was the OB-72 - a cleverly designed, beautifully made and exquisitely finished sliding folding door system that features a unique free-glide running system.

Offering sightlines of 72mm and chamfered beading, it provides a more traditional style and given its innate strength, it means that it can accommodate door sets of up to twelve doors in a single configuration, as well as corner bi-fold set ups.



Product displayed: OB-72
Colour shown: Anthracite Grey - 7016M

Inspired by colour...



Make it everything you've always wanted, make it yours

With over 150 different RAL shades to choose from, you can be sure to find a colour that suits your style, no matter how subtle or outrageous it may be.

Ranging from bright primary shades through to candy pastels and deeper earthy tones, our extensive colour palette is guaranteed to offer inspiration to homeowners and interior designers alike.



To take this even further, you can take advantage of our dual colour option, which means your exterior colour can complement the building style while the interior frame can blend in or contrast with your colour scheme inside. Many of our RAL colours also come with the option of offering a matt, satin or gloss finish.



In order to make this finish truly flawless, the highest grade power coating is applied to our aluminium. Durable yet smooth to the touch, it offers the benefit of being highly resilient to the elements.

Your doors when you want them

Should you decide on one of our popular colours, you will benefit from a never seen before lead time...

Origin's 'Your Lead Time, Not Ours' delivery promise means that the door's delivery date can be specified at the point of ordering, so the manufacturing schedule is controlled by your requirements.

Whether it's for a day, a week or a month's time, Origin can deliver.*

Popular colours span from Hipca White to Jet Black and cover all the metallic shades in between. Also included in the popular range colour range is a timeless dual colour option and two authentic looking woodgrain finishes.** View page 9 for our popular colour range.

To view the colours that are available on a 24-hour lead time, please see page 9*

*Delivery will be made to your chosen Partner and their availability will dictate your installation date.
**Woodgrain options are only available on the OB-72.





The slave and D-handle – both of which have been specifically designed by Origin to withstand a pull of 1600 Newtons – are available in any one of the 150 RAL shades or a stainless steel effect finish, so they can be matched or contrasted to the door itself.



Product displayed: OB-72
Colour shown: Pale Green - 6021S (out)
and Hipca White - 9910G (in)

Bespoke to you...

With Origin, the only limit is your imagination

Your home, your doors – with all the little details just as you want them. As with everything Origin, all of our products are bespoke and custom to you, and the Origin Door is no exception.

Your door can be specified from one through to twelve door sets, and individual door leaves can be as narrow as 325mm, as wide as 1,200mm and as tall as 2,876mm, so there is guaranteed to be a configuration available that will suit your requirements.

Whether you opt for the OB-49 or the OB-72, your home will benefit from a sophisticated and timeless feel as the doors allow a flow of natural light to stream in, helping provide a new transitional way of living and changing the way you interact with your outside world.

Working with your chosen Partner, specify your preferred system, overall size, number of doors, configuration, internal and external colour, your preferred threshold option, whether you want the doors to open in or out, handle style and colour, and if instructed by you, they will direct us to create the architectural dream that is the Origin Door.

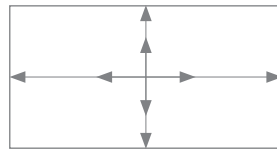

Overall size

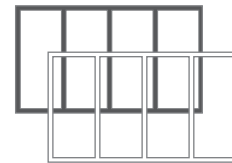

System

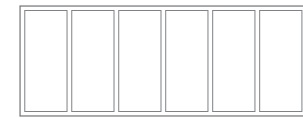

Number of doors

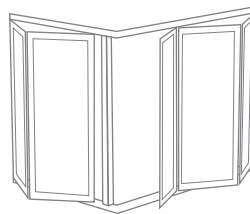

Configuration

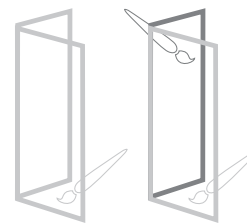

Single or dual colour

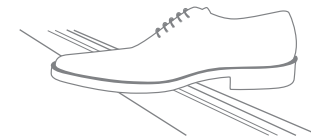

Threshold option

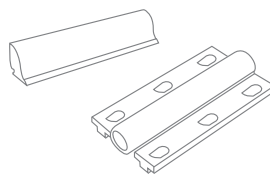

Accessory finishes

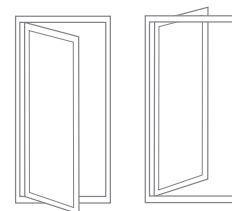

Open in or out

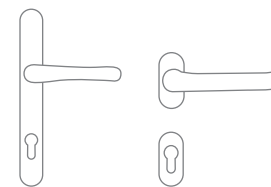

Handle model

Popular colours...



Dual Colour:

9910G (Hipca White) in, 7016M (Anthracite Grey) out

Colours shown throughout this brochure may not be 100% representative. Visit your local showroom or contact Origin directly for physical samples.

Even the gasket and seal colour is your choice

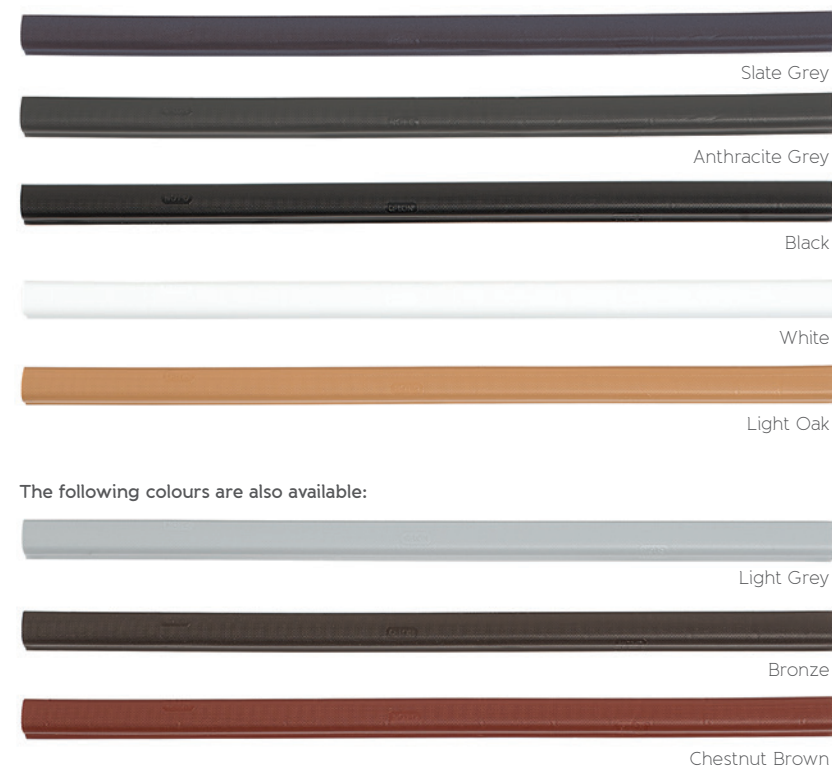

Door colour	Recommended seal colour
A. 7015M and 9007M	Slate Grey
B. 7016M	Anthracite Grey
C. 7021M and 9005M	Black
D. 9910G and 9910M	White
E. Natural Oak and Golden Oak	Light Oak

Hardware, components and accessories...

Little things that mean a lot

We've left nothing to chance in the creation and manufacture of the Origin Door. Every detail has been scrutinised, every process meticulously tested and every component designed to ensure all elements perform flawlessly.

As Origin exclusively design and manufacture the award-winning products at our Buckinghamshire based factory, it means that everything is centrally controlled, from sourcing right through to delivery.

This includes the design of all of the components that make up the Origin Door, ensuring that true innovation has been engineered at every level, because for us, having components that are specifically designed for purpose offer a better performance, rather than a one size fits all, off-the-shelf solution.

Take the gearbox for example - it may be small, but don't underestimate its contribution, power or importance. It's responsible for operating the shoot bolts and locking the doors in place. Its lightweight structure has been meticulously tested to the extremities to enhance performance without compromising on security.



Hinge



Gearbox



Track

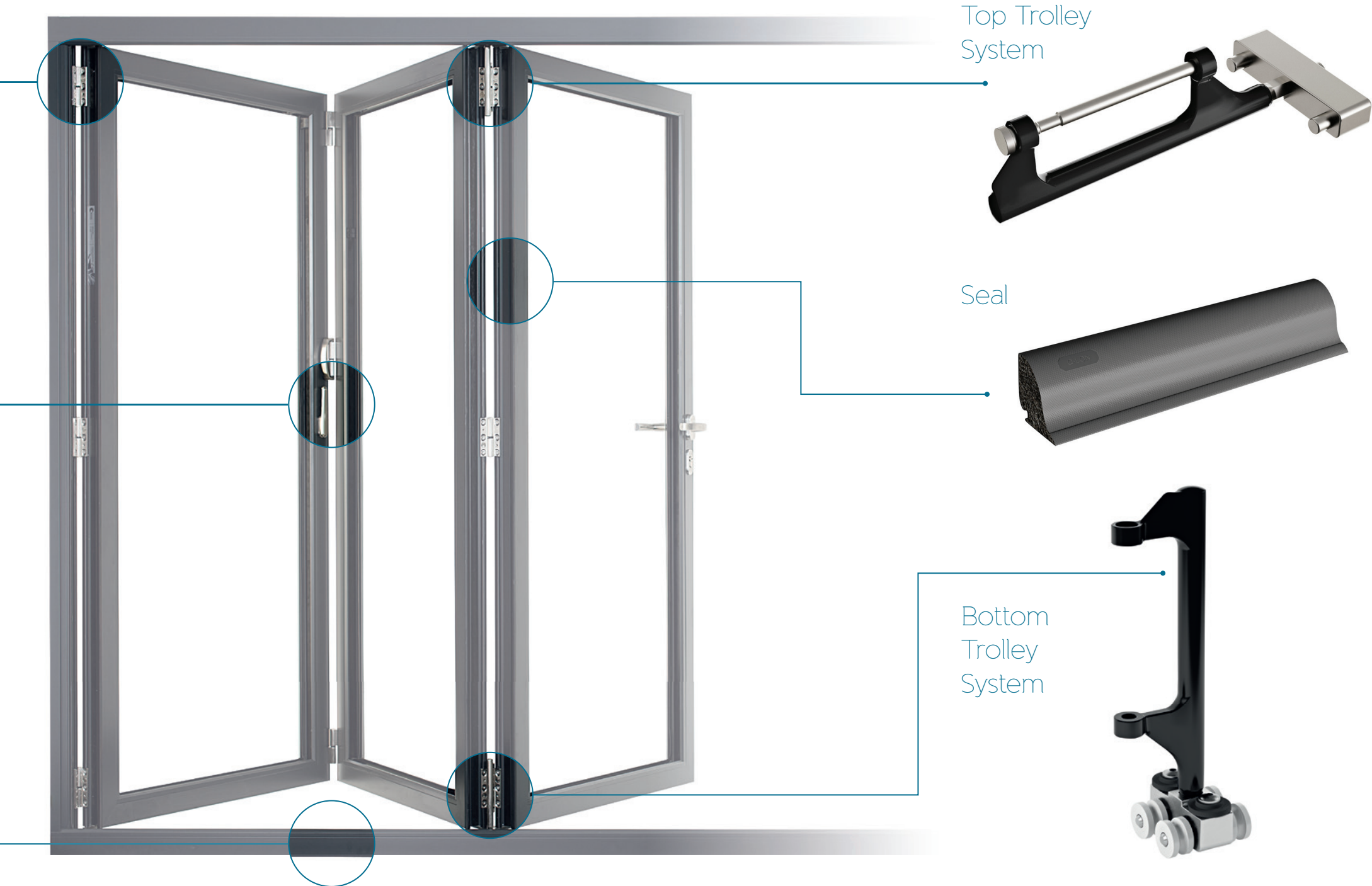

Top Trolley System

Seal

Bottom Trolley System

Life with no boundaries...

The slim sightlines and expanse of space offered by the Origin Door can transform a home by removing the barrier between the inside and out. The bespoke nature of every Origin Door means that you can reduce that barrier further through a choice of thresholds.

Weathered, non-weathered and mobility options are available, so you can pick the right option for your home depending on where the doors are going and how exposed to the elements they will be.

With our cleverly engineered weathered option, the track can be recessed and sunk into the floor, leaving a minimal step into your new space. This threshold type ensures a home is kept watertight and weather protected.

Non-weathered options offer a level floor finish and create a seamless transition between inside and out. Non-weathered options are largely recommended for internal usage. Mobility thresholds are only available on French and single doors.

Weathered, non-weathered and mobility thresholds are available





Product displayed: OB-72
Colour shown: Hipca White - 9910G (out)
and Anthracite Grey - 7016M (in)

Aluminium...

Style and slim sightlines are nothing without the strength and security that aluminium brings

Extremely strong yet weighing 67% less than steel, Origin uses premium grade aluminium across all products.

Needless to say, as with all things Origin, the aluminium that we use is far from average. We only use prime billets - none of the aluminium we use has been made up from re-melting scraps - which ensures much better control over the overall formulation, allowing a greater finish to be achieved.

Additionally, another reason for aluminium being Origin's material of choice is because it's infinitely recyclable. Read more about our environmental accreditations on page 41.

Our aluminium brings benefits that you can and can't see. In terms of those you can't see - its innate strength makes the doors physically secure, energy efficient and highly durable. The frames are also resilient to flexing, warping and corroding in varying weather conditions.

Our aluminium is hugely versatile and strong enough to easily accommodate complex door layouts, such as moving corner posts without being too heavy..

As for the benefits you can see - you will only need to touch and feel an Origin Door to understand.

The sightlines of an Origin Door are stunningly slim to ensure a maximised view, and the frames have the highest grade powder coating, to ensure an overall superior finish.

It's the quality, strength and durability that aluminium brings that allows Origin to provide such long guarantees.

Our aluminium brings
benefits that you can
and can't see



See page 41 for more information on our environmental accreditations.

Product displayed: OB-72
Colour shown: Anthracite Grey - 7016M

To stand the test of time...

The Origin Door has been
engineered to perform and
built to last

Exclusively designed, developed and manufactured by us in our state-of-the-art UK factory, when choosing Origin, you can guarantee yourself of something special.

At each stage of the manufacturing process, each door undergoes rigorous quality testing, which ensures that it leaves the Origin factory at a consistently unparalleled standard, making the Origin Door and its level of quality very rare.

Our in-house R & D team work on a continuous cycle, tirelessly ensuring that each component, manufacturing technique and all features such as security, thermal efficiency and safety are optimised to maintain and excel in putting Origin at the forefront of design and manufacturing excellence.

The likes of our uncompromising quality control, finely tuned components, precision engineering and exceptional craftsmanship all combine to enable Origin to offer a guarantee of up to 20-years on parts for complete peace of mind.*

**Guarantee based on location of where the doors will be installed.
Visit origin-global.com for full Terms and Conditions.*





Uncompromising quality control, finely tuned components, precision engineering and exceptional craftsmanship all combine to enable Origin to offer a guarantee of up to 20-years on parts for complete peace of mind*

See page 39 for more information on our quality accreditations.



Origin have developed an outstandingly secure and completely unique 8-point locking system

Product displayed: OB-49
Colour shown: Pebble Grey - 7032M

Safe and secure...

A home isn't a home without safety

Because of the sheer importance that security has on an overall system's performance, it is always a critical design priority for our in-house R & D team, and this is certainly the case for the OB-49 and OB-72.

The lock

We're proud to have developed an outstandingly secure and completely unique 8-point locking system that can be used across both the OB-49 and OB-72. Not only does it conform to all the latest security standards including PAS 24, but it also achieves the prestigious Secured by Design status.

Our unique 8-point locking system offers an incredibly flawless performance and ensures your home is kept safe and secure. Chamfered 20mm linear bolts offer a smoother operation when engaging the lock, as well as giving maximum compression for increased weather resistance.

Add deep throw 25mm security hooks - the deepest engagement available on the market today - and the lock delivers the best in both security and weatherproofing.

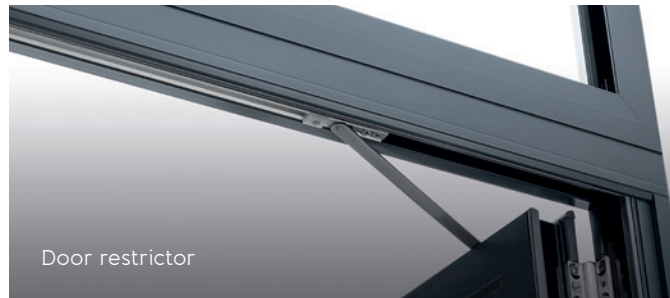

Door restrictor

Barrel options

The OB-49 comes with a 3-Star Diamond, British Standard Kitemark locking barrel as standard. These barrels are proven to protect against snapping, picking, drilling and bumping, offering a defence that is second to none.

The OB-72 can be upgraded to include the barrel as mentioned above, but if you opt not to go for this, it will be equipped with a reliable 1-Star barrel which makes forced entry difficult, preventing thieves and entry breaks occurring via the locks. There are also thumb-turn barrel options available to cater to your lifestyle.

Other security features

On both systems, we have specifically designed hinges that are engineered to help withstand attacks, offering little opportunity for even the most determined intruder.

We offer either a 90° or 135° door restrictor that will limit the door's opening to the respective angle.

All of this, on top of the innately robust and strong aluminium profile, makes for two ultra-secure systems.

See page 38 for more information on our Secured by Design accreditation.



Thermal efficiency...

It may not seem that a classic style goes hand in hand with thermal efficiency, but it certainly does with Origin

Designed specifically to meet the demands of the UK market, the Origin Door has been engineered to optimise superior weather rating, security and aesthetic appeal. While each of our doors invite natural light in and remove the barriers between the inside and out, they also work to keep a home warm when it's chilly and cool when it's hot.

Origin exceeds British Building Regulation requirements for optimal thermal efficiency as both the OB-49 and the OB-72 boast certified U-Values as low as 1.1 when using triple glazing.

The Origin Door also makes use of some of the most sophisticated weathertight seals to ensure the elements stay out.

In real terms, this means your Origin Door will help reduce energy bills and your rooms will become usable all year round.



Product displayed: OB-72
Colour shown: Anthracite Grey - 7016M



Low maintenance...

Origin makes it possible to enjoy your home without the worry of time consuming and complicated maintenance

The very nature of bi-folding doors demands precision driven design and engineering - something that materials such as timber and uPVC just can't measure up to, as they won't maintain alignment over the lifetime of the product.

Our high grade aluminium retains a consistent shape, barely contracting or expanding, whatever the weather. It's guaranteed to offer the right combination of strength and weight to allow for a narrow, more aesthetically pleasing frame which will work flawlessly for decades to come.

Its impeccable powder coated finish removes the need for periodic painting and demanding maintenance*, so you can relax, knowing it's one less thing to worry about.

**More routine maintenance will be required in certain areas. Visit origin-global.com for full Terms and Conditions.*

Poetry in motion...



Product displayed: OB-49
Colour shown: Anthracite Grey - 7016M



Free glide system...

The flawless operation of the Origin Door is a thing of wonder.

The secret behind this effortless, smooth motion can be found in the bottom section of every door. An intelligently engineered short wheelbase carriage assembly with four wheels, manufactured from a high grade acetal, guides the doors along the track seamlessly, enabling them to open and close with ease.

The slimline carriage has been designed to ensure a quiet and efficient operation, meaning that with a gentle push, a whole new living space is revealed.

It's quality that can be
seen, felt and admired



Magnetic catches can help hold the doors in place while you operate them.



Weathered and non-weathered threshold options are both ideal for wheelchair access.

Keeping the family safe...

Nothing is more important than safety and reliability in a home, which is why the Origin Door incorporates features that all of the family can benefit from.

The doors boast finger safe gaskets to prevent little fingers getting trapped when the doors are closing, magnetic catches that can temporarily hold the doors in place whilst being operated, and threshold options which minimise boundaries, creating a seamless link between the inside and out. They are also ideal for wheelchair access.

And because of the stringent quality control Origin have over all elements - aluminium checks, component performance tests and training regimes - it means that stress, worry and concern are replaced with complete peace of mind.



Further design opportunities...

Helping further broaden your design scope, on top of a fully glazed door, you're also able to specify your Origin door with the following:

- Glazing bars
- A mid-rail to separate the top and bottom sections
- A mid-rail with a panel at the top or bottom for additional privacy
- Plain panel



Fully glazed door

Glazing bars

Mid-rail

Mid-rail with half panel

Plain Panel

These designs lend themselves and pay tribute to the almost lost notion of a traditional back door. They offer more privacy than a fully glazed door, and can be specified on any configuration, whether it be on Bi-folds, corner doors, French or single doors.

Elegantly executed, if the mid-rail is selected, it can be fixed horizontally and is available at either a 50:50 or 60:40 split.



Product displayed: OB-72
Colour shown: Jet Black - 9005M

Handled with care...

The handles of an Origin Door are the perfect finishing touch to the exquisitely designed system

In addition to striking the optimum balance between superior strength and a sleek design, our handles are exhaustively cycle tested so they mirror the flawless functionality of the doors, ensuring they stand the test of time.

OB-49 handles

As standard, the OB-49 comes with a handle from our stainless steel range, which for a specific look and feel, can also be colour coordinated to match or contrast your chosen door colour.

Stainless steel range



Style 253/280



Style 251/280



Style 301/280



Style 303/280



Style 253/270

With the exception of the 253/270 handle which features a long back plate, each model is supplied with a separate escutcheon.

Certain models can be colour coded in any RAL shade.

OB-72 handles

For the OB-72, choose from a selection of elegant handle styles and rest assured that they have been designed and manufactured with the same care and dedication as every other component. With no compromise on quality, your doors will come with our ultra-secure aluminium handle as standard which is available in three popular finishes. The OB-72 can also be upgraded to the stainless steel handle range, of which most are able to be specified in any RAL colour.

Offset lever handle range



White aluminium
lever handle

(LCSH-LLWH)



Chrome aluminium
lever handle

(LCSH-LLCH)



Black aluminium
lever handle

(LCSH-LLBL)



Slave and D-handles are available in any one of the 150 RAL shades or can be specified in a stainless steel finish. These are used across both the OB-49 and OB-72.

Product displayed: OB-72
Colour shown: Jet Black - 9005M

Door types...



Product displayed: OB-72
Colour shown: Jet Black - 9005M

Bi-fold Door

The door that started it all.

Origin Bi-fold Doors come in configurations ranging from two to twelve door sets, and can create an entirely new living space - all it takes is a gentle push.

Individual doors can be manufactured as narrow as 325mm, as wide as 1,200mm and as tall as 2,876mm, and the folding and sliding choices are there to help ensure you make the most of your space.

Please see page 34 for a rough indication of sizes and popular configurations.



Product displayed: OB-72
Colour shown: Stone Grey - 7030M



Product displayed: OB-72
Colour shown: Anthracite Grey - 7016M

Corner Bi-fold Door

Put simply, we know that there are times when conventional door sets just won't do.

No matter the type of build or how unconventional the layout, we can work with you to ensure that you're making the right use of your space with the right door.

Origin's Corner Bi-fold Doors allow for a point of light in an area which would usually be shaded, and can be manufactured with or without fixed posts for a truly unrestricted panoramic view.



French Door

Traditional styling with a modern touch, Origin French Doors are great for areas where space is at a premium, to ensure you get the most from your view.

French doors can standalone in widths ranging from 936mm – 2,536mm and can be as tall as 3,000mm (without a cill). Additionally, flags or fixed panels can be added either side to fit into larger openings.

The French Door can feature a mobility threshold for ease of access.



OB-49
OB-72

Product displayed: OB-49
Colour shown: Pebble Grey - 7032M



Single Door

Origin offers a single door option, which is manufactured with the same care and attention to detail as the rest of the Origin Home Collection, ensuring a truly harmonious look.

Our single door uses the same beautiful profile as our bi-folding doors, and are perfect as a side exit or utility door.

The single door can also be specified with a mobility threshold.



Glazing Bar Door

Origin Doors not only offer access to indoor / outdoor living, but can also be tailored to suit any property style whilst enhancing the character.

Sometimes referred to as Georgian bars or steel effect bars, our glazing bar doors offer a unique period style effect with a modern feel.

The bars can be placed horizontally, vertically or both as a grid effect and are able to complement a traditional, modern or commercial look without compromising on the amount of light coming in.



Product displayed: OB-72
Colour shown: Anthracite Grey - 7016M



Configurations...

Choosing your Origin Door has never been easier. If you know your rough opening size, find the nearest opening measurement in the table below and scan down the column to view your possible door options.

Alternatively, if you're set on a particular number of doors and you are designing your opening around them, select your preferred number of doors in the left column and scan across to identify the opening sizes available to you. Remember, every door we make is bespoke and manufactured to your exact sizes and chosen configuration. The next page will run through the available options.

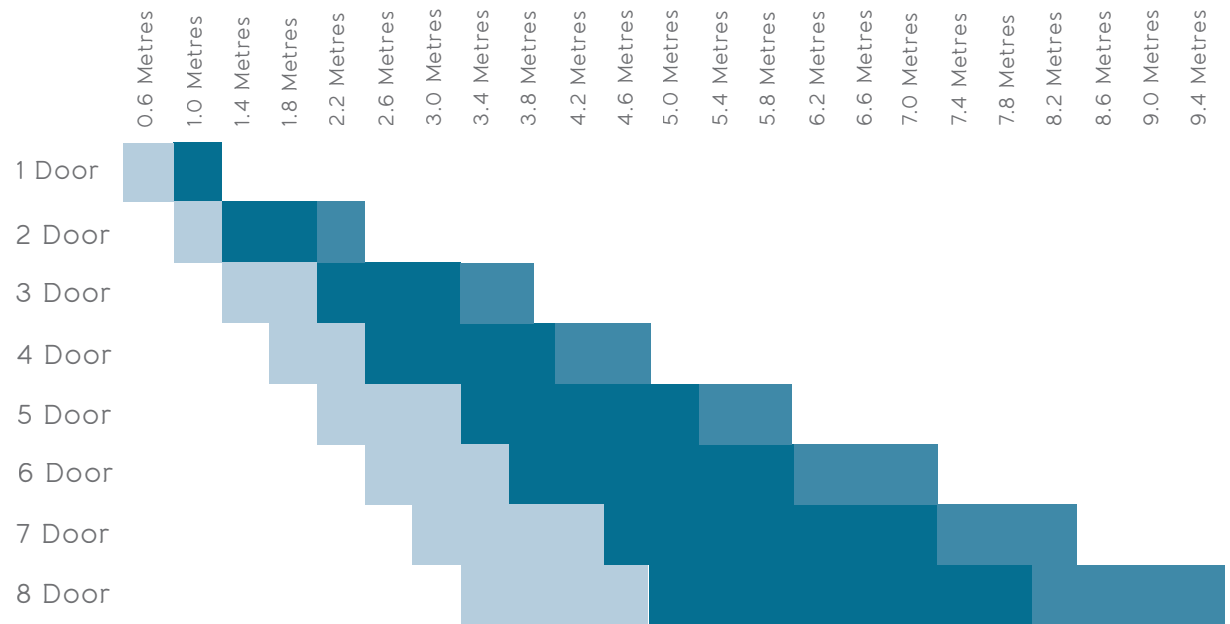

Configurations are available up to twelve doors. Above sizes are for guidance only and are subject to glass specification.

Key

- Optimum door leaf sizes
- Wide door leaf sizes
- Narrow door leaf sizes

Single door

1 Door



Manufactured in the same high grade aluminium as every other door type, the single door is great for ensuring a matching, complementary style. It can be used for any purpose including side exit, utility or even back door.



2 door configurations:

2 Door 2+0



Our 2 door sets work for small openings. This door type comes with a mullion and can be specified with a slave locking barrel.



2 Door French Door



The Origin French Door matches our bi-folding doors perfectly. It comes with our leading multi-point locking system.



3 door configurations:

3 Door 3+0



We recommend the 3+0 configuration as it allows for all doors to be folded back in the same direction whilst incorporating an everyday access door.



3 Door 2+1



Key



Everyday access door



Mullion



Manufactured in the UK



Multi-point lock



20 YEAR Up to a 20-year guarantee



Bespoke



4 door configurations:

4 Door 3+1



The 3+1 is a favourite because it will give an everyday access door, multi-point lock and no mullion. It can also offer a French Door effect one side, with the additional benefits of bi-folds on the remaining doors.



Also available:

4 Door 4+0

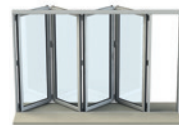

4 Door 1+1 with fixed side panels



5 door configurations:

5 Door 5+0



This configuration works almost identically to the 3+0 configuration, meaning it comes with an access door, multi-point lock and no mullion.



Also available:

5 Door 4+1



5 Door 3+2



Product displayed: OB-72

Colour shown: Hipca White - 9910G (out)
and Anthracite Grey - 7016M (in)

6 door configurations:

6 Door 3+3



Ideal for larger apertures, the 3+3 is one of the most diverse configurations as it can operate as a French door in the centre, have 3 doors opening one way whilst the other 3 remain closed, or they can be opened fully with 3 doors folding each way to offer complete symmetry.



7 door configurations:

7 Door 3+4



This door set will allow you to have an everyday access door, with our multi-point lock. We also recommend this configuration due to its ease of operation.



Also available:

6 Door 6+0

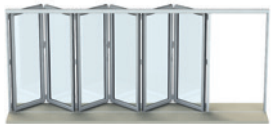

6 Door 5+1



Also available:

7 Door 7+0

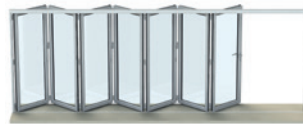

7 Door 6+1

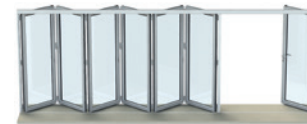

7 Door 2+5

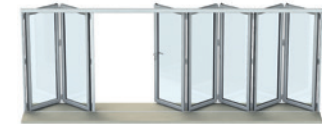

Key



Our accreditations...

At Origin, we pride ourselves on providing best quality products backed by best levels of service and efficiency. Put simply, our aim is to continuously learn, evolve and improve.

We are well known for having rigorously high standards in everything that we do. We're also known for innovation, but we never want to settle: if there's a way that we could do something better, we will find it.

This ethos has been instilled throughout Origin. Whether it's a process, product offering or even the company's sustainability, we have created a culture that encourages continuous improvement.

To demonstrate our commitment and as a way of measuring our performance, we work towards gaining certain prestigious accreditations. Our achievements show a strong moral and ethical intent in how we operate and how we try to do things the best way, not because we are told to do so, but because we think it is the right thing to do.

Here are some of the ways in which we continuously aspire and strive to be better.

Secured by Design

Secured by Design (SBD) is a national, police-backed standard, associated with security and levels of performance for weather, operation and quality on domestic properties. The flagship UK police initiative was originally introduced to help 'design out' crime through the use of high-quality, innovative products and market-leading processes.

It recognises that our doors and windows have not only been tested to the required security standards, but that they also adhere to the rigorous test standards required by the police.

This independent certification involves initial testing of the products and regular re-tests, as well as inspections of our manufacturing and production facilities, to ensure the correct processes are maintained constantly over time, providing more secure and reliable products.

In order to be able to apply, we first needed to achieve:

1. PAS 24 (Enhanced Security)
2. BS EN 6375 Part 1 (Weathertightness)
3. BS EN 6375 Part 2 (Operational and Strength Characteristics)
4. BS EN 6375 Part 3 (Basic Security)
5. ISO 9001 (Quality Management)

We're proud to say that our products passed every one and SBD, so you can feel secure by choosing Origin.



Product displayed: OB-49
Colour shown:
Jet Black - 9005M

ISO 9001 – Quality Management

ISO 9001 is an international standard that assesses a company's quality management system. Having first achieved it in 2013, the fact that we are still certified means that we have a track record of consistently providing products and services that meet both customer and regulatory requirements.

It's something that we take very seriously and its influence is integrated into every process. Key areas of this include:

Product quality – to ensure a product's overall manufacture is flawless, we have checks in place to guarantee you the best quality.

A few examples are:

- Supply chain – an inspection at the point of delivery and before going into manufacturing. If anything is spotted, it's documented and raised with the supplier.
- Production – there are quality checks at every station, not only to look over the previous person's work, but to review the quality of the overall build.
- Equipment – a robust maintenance schedule for machinery and equipment ensures consistency.
- Pre-delivery – before products are packaged and loaded ready for delivery, there's another thorough check to ensure nothing's happened whilst being moved from station to station.

Feedback – as part of our mission to always innovate, whether it's from internal or external stakeholders, feedback is imperative. We are very proactive at bringing this type of information back into the business and learning, as it gives us an opportunity to improve.

Training and development for our employees – meaning we're better at understanding the good, the bad, and what we can do better.



FS 584084



ISO 45001 – Health and Safety Management

Whether it's through improving homes with our products, or in our workplace, people are at the heart of everything that we do at Origin, so we are very proud to have achieved a triple badge accreditation when we received our latest accolade - ISO 45001.

ISO 45001 recognises our commitment to employee safety and reduction in workplace risks to create a better, safer working condition.

We have spent time reviewing all the activities that go on within the offices, manufacturing centres and warehouses, and have created a full risk log which will link up to our current risk assessments. These are fed back so they can be actioned to be rectified or developed into an improved method of operating.

We actively encourage our teams across the business to report any observations that they have so that we can continue to improve and ensure that safety at Origin is at the best standard possible, for everyone.

This means that you can buy from our range safe in the knowledge that we are minimising risks as much as we can for optimum safety.



OHS 711491



Product displayed: OB-72
Colour shown: Anthracite Grey - 7016M

ISO 14001 – Environmental Management

Now more than ever, we need to be aware of the impact our operations may have on our environment; the legal obligations we must adhere to, and ensuring we are doing things the right way.

The internationally renowned ISO 14001 accreditation measures the environmental management system that we have in place. It's a subject that's very close to our hearts, which is why working towards this standard was an easy decision.

We care about the resources we use for our products – where they come from and where they end up. To add to this, we aim to be zero waste to landfill and have already put into place many positive changes to make this happen. We want our customers to buy from us with a clear conscience and feel that ISO 14001 can prove that Origin is taking responsibility, acting ethically, legally and exercising best practice in all that we do.

Our environmental management system covers:

- Waste management and energy targets – to reduce our consumption and impact on the environment. Helpful hints, tips and reminders are prompted to all staff regularly, so that they can join us in our goal and see how small changes to their work practices can have a big impact.
- Product design and lifecycle – recyclability and sustainability are a design priority for us.
- Supply chain – choosing suppliers that are aligned with our ethos and vision. This is applicable not only when bringing on new suppliers, but also working with existing ones to better their carbon footprint – whether that's minimising packaging, reusing or even our drivers picking up the materials on their routes, rather than a supplier sending their own fleet, we are constantly reviewing how we can improve.



EMS 745310

BES 6001 – Responsible Sourcing in Construction

Also known as the BRE Environmental and Sustainability Standard, it is a framework that assesses the responsible sourcing construction products. Developed by the Building Research Establishment (BRE), it provides a robust methodology for evaluating the sustainability credentials of manufacturing materials and products.

BES 6001 focuses on three main pillars: social, environmental, and economic sustainability. It sets criteria for responsible sourcing practices, including the responsible sourcing of raw materials, ethical supply chain management, and environmental impact reduction throughout the product's lifecycle.

By achieving BES 6001 certification, we can demonstrate our commitment to sustainable practices and provide reassurance to customers and stakeholders. This standard encourages transparency, drives continuous improvement which is at the core our practices, and helps create more sustainable buildings and construction infrastructure.

Overall, BES 6001 plays a significant role for Origin in promoting sustainable development within the business by setting clear guidelines for responsible sourcing and encouraging the adoption of environmentally friendly practices.



BES 774575



Rest assured...
with Origin, all
of our products
are exclusively:

- designed
- engineered
- manufactured
- delivered
- guaranteed
- supported

...in the UK, by us

Practical information...

Planning permission

Determining whether or not planning permission is required will largely come down to the project that you have in mind. If you are replacing old patio doors with a new door system and you're not in a conservation area, it's unlikely that you'll need planning permission.

If, however, the doors are part of a larger project, an extension, conservatory or orangery for example, then planning permission will more than likely be required. Similarly, if you are in a conservation area, it will most definitely be needed.

If you're not sure, check with your local authority to find out if your home is subject to any planning restrictions or conservation policies. In all instances, your chosen installation partner should be able to guide you through the process.

Trickle vents

Should it be required, the Origin Door can be specified with discreetly designed trickle vents which are installed through the top track for additional ventilation, ensuring the doors meet and surpass building regulations.

Glass and glazing

The Origin Door Collection is able to accommodate double or triple glazing, with glazed unit sizes of either 24mm, 28mm or 32mm. If directed by you, your chosen Partner will be responsible for sourcing the glass, and they should be able to guide you through the process of selecting what's right for you, whether that be annealed, toughened, tinted or even patterned.

The manufacturer

In the fenestration industry, the brand of the product is rarely the company that manufactures it. A major consequence of this method means that quality can vary drastically between one manufacturer and another, so there is no guarantee that the doors produced are to the parent company's specification and quality standards.

This is where Origin are different. Unlike the rest, Origin keep full control of the product from start to finish.

The next step...

Once you're set on turning your house into an Origin Home through the installation of award-winning doors and windows, visit origin-global.com to find your local Origin Partner and details of their showroom.

Whilst our nationwide network of Partners are independent companies from Origin, they have been offered training to ensure you receive the greatest quality product that's backed with a reliable and helpful service.

If instructed to by you, your Origin Partner or third party installer will be undertaking your installation, so they are best placed to discuss your building project and costs with.





Origin is the UK's leading manufacturer of aluminium architectural solutions.

Now award-winning and operating internationally, Origin began in 2002 as a family company dedicated to the design, creation and manufacture of the UK's best quality doors, backed by uncompromising levels of service.

Cousins, Neil Ginger and Victoria Brocklesby, have since worked relentlessly to perfect the design and functionality of bi-folding doors, and to create and maintain the highly respected reputation for quality and service that they have today, while expanding the range to include Internal Doors, Residential Doors, Sliding Doors and Windows.

As the business has continued to grow and diversify, the foundations of family ethos, pride and ownership in all stages of production firmly remain.

Origin Global HQ, Stuart House,
Castle Estate, Coronation Road,
Cressex Business Park,
High Wycombe,
Buckinghamshire,
HP12 3TA

t 0808 168 5816
e enquiry@origin-global.com
w www.origin-global.com

Origin USA, Inc.
573 Paul Morris Drive,
Englewood,
Florida,
34223
USA

t +1-941-484-4861
e info@originbifolds.com
w www.originbifolds.com

Origin Middle East and Africa,
Oryx Door Systems LLC,
28 29th Street,
Al Quoz Industrial Area 4,
Dubai, United Arab Emirates
PO Box 282696

t +971-4-341-9447
e info@originuae.com
w www.originuae.com

