



RESIDENTIAL INTERNAL DOORS

NEW. Glass doors in loft design, real wood veneer doors, reverse-opening doors, Zeroline frame

HÖRMANN





4

Good reasons to try
Hörmann residential
internal doors.



14

Door styles.
Inspirations.



84

Design.
Equipment.
Accessories.

Responsibility for generations

The Hörmann family business has over 85 years of experience as a construction component specialist. This gives us an obligation to both current and future generations. That's why environmental responsibility plays such an important role for us. With this in mind, we develop innovative solutions for sustainable products and intelligent environmental protection.



“A GOOD REPUTATION MUST BE EARNED.”

August Hörmann

In keeping with the tradition started by the company’s founder, the Hörmann brand is a true promise of quality and, with sales of over 20 million doors and operators, is one of Europe’s most successful suppliers. Due to the comprehensive international sales and service network, Hörmann is your strong partner for high-quality construction components.



WE THINK AND ACT GREEN. As a family business, we are very conscious of our responsibility to future generations. The Hörmann climate protection strategy aims to reduce and avoid CO₂ emissions. We cover 100% of our electrical power needs at all European production locations with purchased green electricity. We are also investing in a clean future with other measures such as the use of recycled paper, CO₂-neutral postal shipping and the recycling of transport packaging to save more than 75,000 tons of CO₂ every year. We work with ClimatePartner to offset the emissions that we do generate by supporting certified climate protection projects. In particular, we offset all CO₂ emissions produced in manufacture of products for residential construction as standard. Products for construction projects are also available as CO₂-neutral versions upon customer request.



You can find further information at www.hoermann.com/sustainability



ClimatePartner
certified product
climate-id.com/XNEBKC



CO₂
measure
reduce
contribute



ClimatePartner
certified product
climate-id.com/FYZNUF



CO₂
measure
reduce
contribute

Brand quality made in Germany





The family-owned company Hörmann offers all important construction components for building and renovating projects from a single source. We manufacture in highly specialised factories using state-of-the-art production technologies. Our employees work intensively on new products, continual further developments and improvements to details. The results are patents and unique products on the market.



LONG-LASTING. GUARANTEED. All doors are developed and manufactured by Hörmann. Endurance tests under real conditions ensure mature series products with Hörmann quality. For this reason and thanks to quality assurance without compromise, you can enjoy a Hörmann residential internal door for years to come. You are literally choosing a door for life.

CONVINCING PREMIUM WORKMANSHIP. For the door and frame construction, we rely exclusively on high-quality timber materials. Screw connections guarantee an excellent fit and seamless frame appearance. Frame reinforcements in the door leaf and sturdy door fittings ensure high stability and resistance. The modern, in-house production technology for the Duradecor surface finish impresses with consistently high quality and an impact resistance that is on average 48% better* than that of tested CPL surfaces of other manufacturers.

 	
KURZBERICHT	
Auftrags-Nr.: 2713082-2013	
Seite 1 von 3	
Auftraggeber (AG):	Hörmann KG Verkaufsgesellschaft Upheider Weg 94 - 98 33803 Steinhagen
Auftrag vom:	11.03.2013
Prüfgegenstand:	6 Türblätter mit CPL-Beschichtung (Variante 1 + 6) verschiedener Hersteller 3 Türblätter mit Duradecor-Beschichtung (Variante 7 - 9) von Hörmann
Probennahme:	Anlieferung durch AG am 14.03.2013
Prüfauftrag:	Durchführung ausgewählter Prüfungen an Türblattoberflächen
Prüfgrundlagen:	<ol style="list-style-type: none"> 1. Bestimmung der Fleckenunempfindlichkeit nach EN 12720/ DIN EN/TS 16209 2. Bestimmung des Verhaltens bei Stoßbeanspruchung mit einer kleinen Kugel gemäß den Prüfbedingungen der EN 438-2:2005, Abschnitt 20 3. Bestimmung der Kratzfestigkeit gemäß EN 15186 Verfahren B 4. Bestimmung der Tesaftfestigkeit gemäß IHD-W-463 und Beurteilung der Prüfflächen gemäß den Bewertungsstufen 5. Bestimmung des Verhaltens bei Abriebbeanspruchung nach EN 438-2:2005, Abschnitt 10 6. Bestimmung der Lichteinheit gemäß DIN EN 438-2, Pkt. 27 7. Bestimmung des Verhaltens gegenüber Wasserdampf gemäß EN 438-2:2005, Abschnitt 14 8. Bestimmung des Verhaltens gegenüber trockener Hitze gemäß EN 12722/ Klassifizierung nach DIN 68861 Teil 7/ DIN EN/TS 16209 9. Bestimmung des Verhaltens gegenüber feuchter Hitze gemäß EN 12721/ Klassifizierung nach DIN 68861 Teil 8/ DIN EN/TS 16209 10. Bestimmung der Haftfestigkeit der Beschichtung in Anlehnung an DIN EN ISO 4624 11. Bestimmung der Wasserdampfdurchlässigkeit mittels Bestimmung der Wasseraufnahme bei einer Lagerung von 14 Tagen bei 20 °C/ 98 % relativer Luftfeuchte, Angabe der Wasseraufnahmemenge in g/m² 12. Bestimmung der Wischbeständigkeit nach IHD-W-471
<small>Der Prüfungsbericht enthält 3 Seiten. Eine auszugsweise Vervielfältigung bedarf der schriftlichen Genehmigung des EPH. Die Prüfergebnisse beziehen sich ausschließlich auf die geprüften Materialien.</small>	

*) except Duradecor ultra matt

Premium quality that you can feel in form and design

Your interior style sets the tone! Are you looking for residential internal doors that harmonise with your home? Get ready to be impressed by the high-quality Duradecor surface finish with vibrant colours, perfectly reproduced timber decors and expressive textures. You can also choose from numerous real lacquer surface finishes and real wood veneers. Or you can design your residential internal doors yourself with the paintable priming film. It doesn't get any more individual than that!





**Extremely
impact-resistant**

PERMANENT DURABILITY. With an impact resistance that is on average 48% better, the high-quality Duradecor surface finish is vastly superior to CPL surfaces from other manufacturers. It is also especially easy to clean, heat-resistant and almost as robust as a kitchen worktop.



No fingerprints

ULTRA MATT. Fingerprints on residential internal doors? Not with Duragrain ultra matt! That's because this surface finish combines high resistance to fingerprints and other soiling with an exquisite matt deluxe appearance in a previously unattainable matt finish. When it comes to both aesthetics and feel, the ultra matt surface finish is in a league of its own!



**Vibrant
colour coating**

VIBRANT COLOUR EFFECT. The lacquered surface of our timber doors has a classic and high-quality look. The even, multi-layer coating on the whole unit, made up of the frames and door leaf, results in a uniform surface finish and a seamless edge transition. The deep and brilliant colour effect is truly impressive.

Impressive right down to the tiniest detail!

We want our residential internal doors to impress you right down to the tiniest detail. You can enjoy your Hörmann residential internal doors for years to come thanks to clever features such as the 4Protect edge guard or our new light-impermeable seal that blocks out light from an adjoining room for an undisturbed and restful night's sleep.





**4Protect
edge guard**

RESISTANT EDGE. The 4Protect edge guard on flush-closing doors and rebated doors with angular edges offers a high resistance to impact, wear and scratches. This means that doors with a Duradecor surface finish are ideally protected against everyday wear and tear.

SEAMLESS WHITE. The rebate edge of all doors with a white Duradecor surface finish is specially coated for a seamless appearance. In addition, the 4Protect edge guard ensures a seamless transition to the door leaf in doors with angular edges. You can enjoy a continuously white door view without the bothersome unsightly edges that standard doors have.



LIGHT-IMPERMEABLE WHITE SEAL. NEW.

Hörmann's brand quality impresses with exquisite details. Take the new light-impermeable seal, for example. With no visible light gap in our flush-closing doors, you'll no longer be disturbed by light from the adjoining room. This seal is only available as optional equipment for on-site fitting from Hörmann.

4Protect edge guard with seamless appearance on flush-closing doors and rebated doors with angular edges

The optional light-impermeable seal blocks out light from the adjoining room.

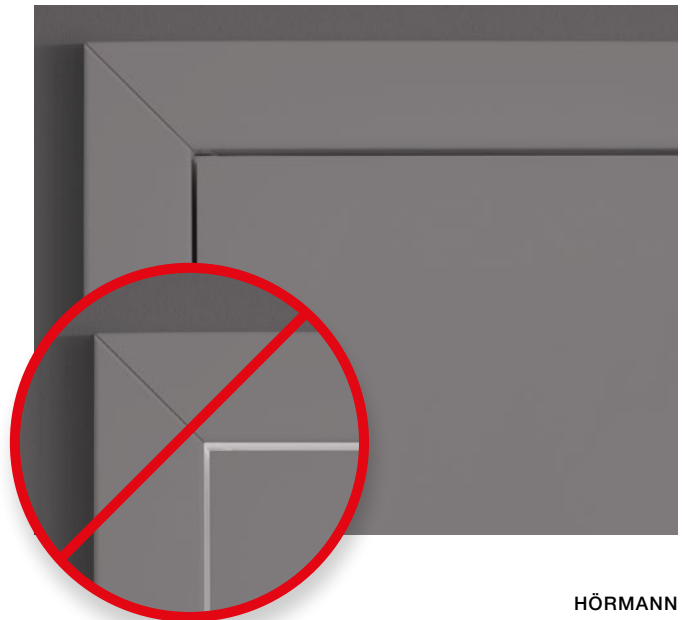

The long-lasting frame

Our high-quality timber and steel frames give your home twice the pep: the elegant, stylish appearance creates a pleasing ambience, and the frames are also extremely durable. Their high-quality, robust design makes them hard-wearing, and they are easy to clean and maintain over the long term.





HIGH-QUALITY TIMBER FRAME. The elegant 3 mm **1** edge radius impresses with a modern rectangular look and a seamless edge finish. The 25 mm-thick jamb lining **2** ensures high form stability, and the premium-quality Duradecor surface finish **3** also makes the frame particularly resistant to impacts and scratches.

→ For further information, see page 86 onwards.



ROBUST STEEL FRAME VARIOFIX. All our residential internal doors are also available with the powder-coated VarioFix steel frame. The corner joints feature high-quality welding and a flush polish. This means that there are no visible mitre cuts in the frame corners. The robust frame construction can withstand run-ins with toy cars and vacuum cleaners. Thanks to the high-quality galvanisation, even cleaning solutions cannot damage the frame.

→ Further information can be found on page 105.



MINIMALISTIC ZERO LINE FRAME. NEW.

The Zeroline frame **4** impresses with its clean lines and minimalist design, enabling a perfectly flush-fitting wall and door leaf, virtually invisible frame construction and concealed hinges. (Fig. **5** Standard frame with flush door leaf)

→ Further information can be found on page 106.



Discover a new level of interior comfort

Are you looking for premium residential internal doors in a classic or modern style, with expansive glazing, elegant accents or a cool loft design? Hörmann can give you the residential internal door that perfectly suits you and your furnishings.





16 ProLine



38 DesignLine



52 ClassicLine

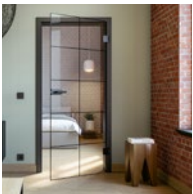

60 GlassLine



66 Steel loft doors

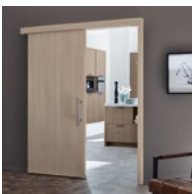

70 Sliding doors

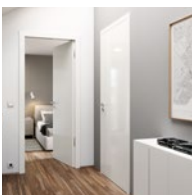

76 Special doors and frames

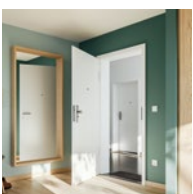

78 Function and construction
project doors



82 Accessories









ProLine

TIMELESSLY ELEGANT. Do you value the feel-good factor in your home? Then the doors from the ProLine series are the perfect choice for you. The door leaf in a flush or rebated version, combined with your preferred colour or your preferred decor, creates a cosy atmosphere that invites you to relax. Discover all design possibilities on the next pages.

Door versions

-  Rebated with rounded edges
-  Rebated with angular edges
-  Flush

→ Further information about the door versions can be found on page 102.



Rebated, single-leaf



Rebated, double-leaf



Rebated, single-leaf with glazing DIN LA



Flush, single-leaf with glazing LA 11



Flush, single-leaf



Flush, double-leaf



Flush, sliding door





**Extremely
impact-resistant**



**4Protect
edge guard**

DURADecOR SMOOTH. The extremely impact-resistant Duradecor surface finish is the right choice for your home. Whether you're keen on elegant White lacquer, modern grey or cosy timber decors, you're sure to find a residential internal door to suit your taste. Our flush-closing doors and rebated doors with angular edges in the Duradecor surface finishes White lacquer, Light grey, Dusty grey, White Parchment and White Ash are equipped with the high-quality 4Protect edge guard as standard.

→ Further information about the Duradecor surface finish and 4Protect edge guard can be found on page 9 onwards.

COLOURS AND DECOR

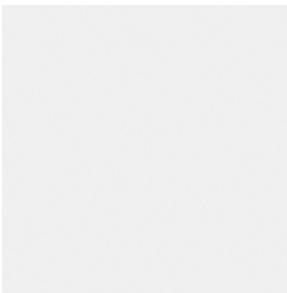

White lacquer RAL 9016

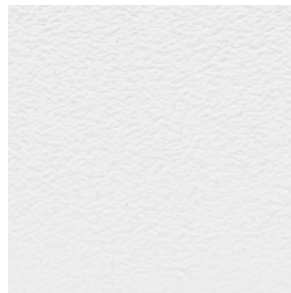

White Parchment

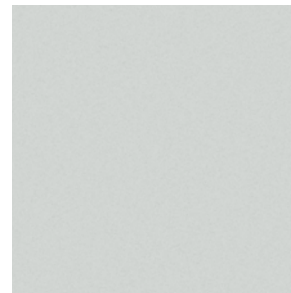

Light grey RAL 7035



Dusty grey RAL 7037

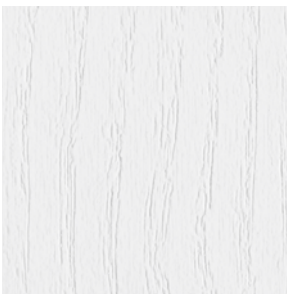

White Ash

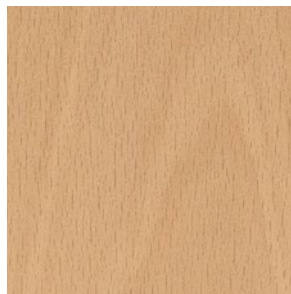

French Beech

The colours and decors shown are subject to the limitations of the printing process and cannot be regarded as binding. All RAL colours based on RAL colour chart. **Please consult with your local Hörmann sales partner.**

LEFT. Flush-closing timber door ProLine, Duradecor Dusty grey RAL 7037, contrasting edge 4Protect in black, lever handle Linea Planar black.edition





Duradecor
Extremely impact-resistant



4Protect
edge guard

DURADecor TEXTURE. This surface stylishly combines a feeling of real wood with ease of care. A wood grain texture is embossed into the door leaf, making the characteristic wood texture palpable. Flush-closing doors and rebated doors with angular edges in the Duradecor texture surface finish Brushed White are equipped with the high-quality 4Protect edge guard as standard.

→ Further information about the Duradecor surface finish and 4Protect edge guard can be found on page 9 onwards.

DECORS



Grey Oak*



Wild Oak*



Brushed White*



Brushed Pine



Brushed Salted Oak



Brushed Larch, light* **.NEW**

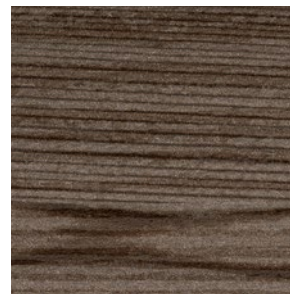

Brushed Larch, dark* **.NEW**



Alpine Oak* **.NEW**



North Oak* **.NEW**

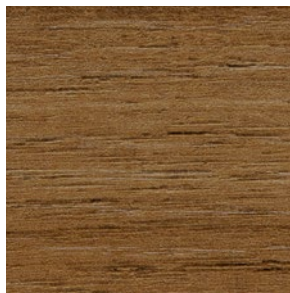

Natural Oak* **.NEW**

The decors shown are subject to the limitations of the printing process and cannot be regarded as binding. **Please consult with your local Hörmann sales partner.**

*) also with vertical grain

LEFT. Flush-closing timber door ProLine, Duradecor Wild oak with vertical grain, contrasting edge 4Protect in black, lever handle Linea Planar black.edition





Extremely impact-resistant



4Protect edge guard



No fingerprints

DURADecOR ULTRA MATT. This particularly elegant surface finish will impress even the most discerning customers in terms of both aesthetics and feel. Ultra matt combines high resistance to fingerprints and other soiling with an exquisite matt deluxe appearance in a previously unattainable matt finish.

→ Further information about the Duradecor surface finish and 4Protect edge guard can be found on page 9 onwards.

COLOURS



White

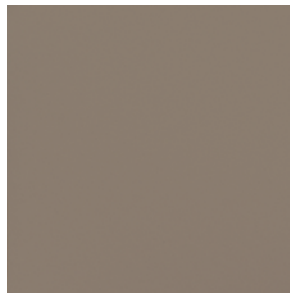

Taupe



Dusty grey

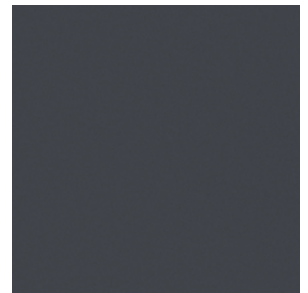

Anthracite grey

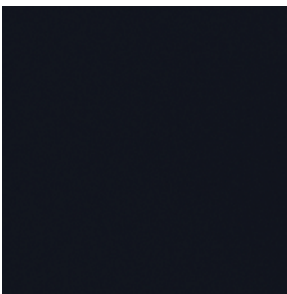

Black **.NEW**

The colours and decors shown are subject to the limitations of the printing process and cannot be regarded as binding. **Please consult with your local Hörmann sales partner.**

LEFT. Flush-closing timber door ProLine, ultra matt Anthracite grey, lever handle Linea matt stainless steel





Extremely impact-resistant



4Protect edge guard

Only from Hörmann

DURADecor SLATE. We recommend this textured surface finish for a modern yet cosy interior design. The light-shadow contrast on the raised texture gives it a very pleasant and natural vibrant appearance. This variant is also available as a glass door.

→ Further information about the Duradecor surface finish and 4Protect edge guard can be found on page 9 onwards.

COLOURS



White



Taupe



Dusty grey



Anthracite



Black **.NEW**

The colours and decors shown are subject to the limitations of the printing process and cannot be regarded as binding. **Please consult with your local Hörmann sales partner.**



GlassLine slate

Clear glass surface (single-pane safety glass) with digital print motif in Black, Anthracite grey, Dusty grey (shown), Taupe or White

LEFT: Flush-closing timber door ProLine, Slate Dusty grey RAL 7037, lever handle Linea black.edition





Extremely impact-resistant



4Protect edge guard

DURADECOR LINEN. With its fine, tangible structure, the Linen surface finish blends particularly well with wood shades and suits a sophisticated, rustic-modern decorative style. At the same time, the surface is robust and easy-to-clean. The Linen surface finish is also available to choose as a glass door.

→ Further information about the Duradecor surface finish and 4Protect edge guard can be found on page 9 onwards.

COLOURS



White



Taupe



Dusty grey



Anthracite

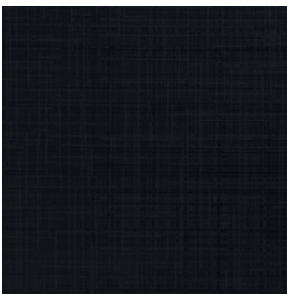

Black **.NEW**

The colours and decors shown are subject to the limitations of the printing process and cannot be regarded as binding. **Please consult with your local Hörmann sales partner.**



GlassLine Linen

Clear glass surface (single-pane safety glass) with digital print motif in Black, Anthracite grey (shown), Dusty grey, Taupe or White

LEFT: Rebated timber door ProLine, Linen Anthracite grey, lever handle Karee black.edition





**Vibrant
colour coating**



**Choice of
RAL colours**

REAL LACQUER. Lacquered surface finishes with brilliant colour effects make your timber doors something rather special. Customise your home with Hörmann's residential internal doors in any RAL colour you desire. Both the door leaf and the frame have a smooth, uniform coating, including a seamless edge transition. The result is a radiant, rejuvenated ambience.

PREFERRED COLOURS



Traffic white RAL 9016



Pure white RAL 9010

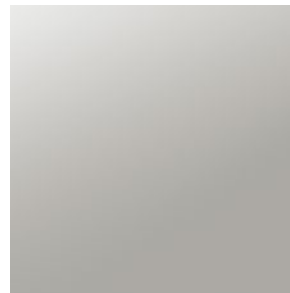

Light grey RAL 7035



Taupe RAL 7048

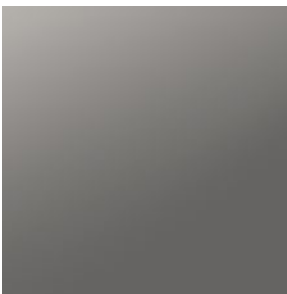

Dusty grey RAL 7037



Anthracite grey RAL 7016



Jet black RAL 9005

The colours shown are subject to the limitations of the printing process and cannot be regarded as binding. All RAL colours based on RAL colour chart. **Please consult with your local Hörmann sales partner.**

LEFT. Flush-closing timber door ProLine, real lacquer Traffic white RAL 9016, lever handle Linea matt stainless steel





**Vibrant
colour coating**

REAL LACQUER MATT. Timber doors with a matt lacquered surface finish are a current trend in high-quality interior design. We have developed our new matt lacquered preferred colours precisely for this purpose. They refine modern interiors and provide for a markedly stylish ambience. The perfectly processed surface finish with an even coating and a seamless edge transition radiates simple elegance.

COLOURS



Traffic white RAL 9016

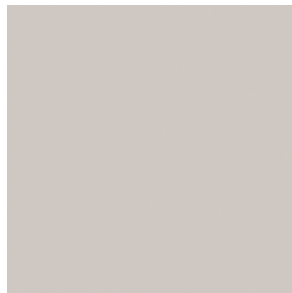

Pure white RAL 9010

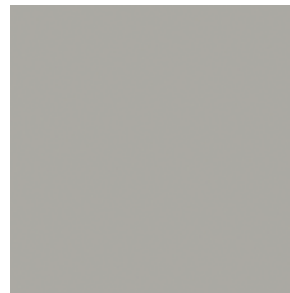

Light grey RAL 7035

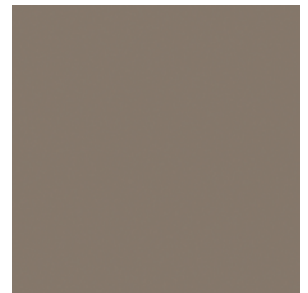

Taupe RAL 7048



Dusty grey RAL 7037



Anthracite grey RAL 7016



Jet black RAL 9005

The colours shown are subject to the limitations of the printing process and cannot be regarded as binding. All RAL colours based on RAL colour chart. **Please consult with your local Hörmann sales partner.**



REAL WOOD VENEER Natural, cosy, unique – Hörmann real wood veneers are produced from high-quality real timber and are truly unique.

VENEERS .NEW



Canadian Maple matt*



Beech matt*



White Oak matt*



Knotty Oak matt*



Limba matt



Sapeli matt*

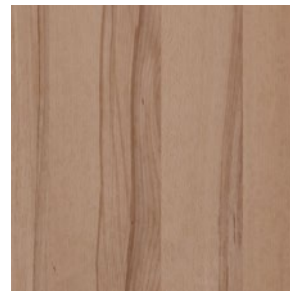

Core Beech matt*



American Cherry Tree matt*



American Walnut matt*

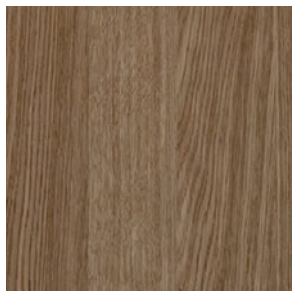

European Oak planked matt



Wild Oak matt*

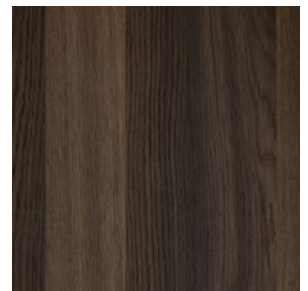

Smoked Oak matt

The veneers shown are subject to the limitations of the printing process and cannot be regarded as binding. **Please consult with your local Hörmann sales partner.**





White Oak matt, Listello



American Walnut matt, Listello



Smoked Oak matt, Listello

Real wood veneer variants .NEW

Listello

This horizontal real wood veneer can be supplied as White Oak matt, American Walnut matt and Smoked Oak matt, and the stripe (measuring around 18 – 28 mm) lends an extremely elegant look.

Quirin

Combining horizontal with vertical veneer grain directions creates stylish door views. This variant is available in all veneers (except for Limba matt, Euro. Oak planked matt and Smoked Oak matt).

Versions

- Q1 with narrow vertical grain on both sides and wide horizontal grain in the middle,
- Q2 with narrow vertical grain and wide horizontal grain,
- Q3 with narrow horizontal grain and wide vertical grain

Black

These three modern door views are created by milled joints in a solid black top strip. This variant can be supplied in Knotty Oak matt veneer with a clear matt lacquer surface finish.



Core Beech matt, Quirin Q1



Core Beech matt, Quirin Q2

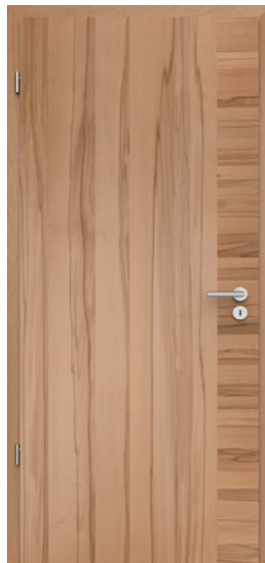

Core Beech matt, Quirin Q3



Style 15
Knotty Oak matt with veneer grain direction and black joints



Style 29
Knotty Oak matt with veneer grain direction and black joints



Style 31
Knotty Oak matt with veneer grain direction and black joints

LEFT. Rebated timber door ProLine, real wood veneer White Oak matt, Listello



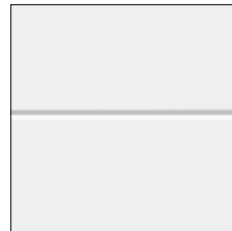

DesignLine Stripe 15

The Stripe style with embossed grooves offers you a tasteful design with a little something extra. Flush-closing doors and rebated doors with angular edges are equipped with the high-quality 4Protect edge guard as standard.



Door versions

-  Rebated with angular edges
-  Flush

-  Duradecor smooth
-  White lacquer RAL 9016
-  Dusty grey RAL 7037

→ Further information about the surface finish and colours can be found in the ProLine section starting on page 19.



Stripe 15
Duradecor
Dusty grey RAL 7037



Stripe 15
Duradecor
White lacquer RAL 9016



**Matching glass door
GrooveGlass 15 / 5**
Clear glass surface
(single-pane safety glass)
with matt style (silkscreen),
stripe width 5 mm

LEFT: Rebated timber door DesignLine Stripe 15, Duradecor White lacquer, lever handle Linea matt stainless steel





DesignLine Groove GlassLine GrooveGlass

GROOVE. The grooves milled into the door leaf and the high-quality lacquer finish make the Groove style an elegant eye-catcher. Matching glass doors are available for the DesignLine Groove styles for the perfect mix of timber and glass doors.









→ Further information about the surface finish and colours can be found in the ProLine section starting on page 19.

Door versions

-  Rebated with rounded edges
-  Rebated with angular edges
-  Flush

Real lacquer / real lacquer matt

-  Traffic white RAL 9016
-  Pure white RAL 9010
-  Light grey RAL 7035
-  Taupe RAL 7048
-  Dusty grey RAL 7037
-  Anthracite grey RAL 7016
-  Jet black RAL 9005
-  Choice of RAL (not for real lacquer matt)



Groove 14
Real lacquer
Traffic white RAL 9016



GrooveGlass 14
Matt glass surface (single-pane safety glass, sand-blasted) with clear style



GrooveGlass 14
Clear glass surface (single-pane safety glass) with matt style (sand-blasted)

LEFT. Rebated timber door DesignLine Groove 85, real lacquer Traffic white RAL 9016, lever handle Linea matt stainless steel



Groove 13



Groove 15



GrooveGlass 15/5
Matt glass surface (single-pane safety glass, sand-blasted) with clear style, stripe width 5 mm



GrooveGlass 15/5
Clear glass surface (single-pane safety glass) with matt style (silkscreen), stripe width 5 mm



Groove 16



Groove 22



Groove 23



Groove 27



Groove 29

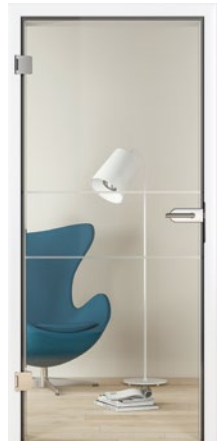

GrooveGlass 29
Clear glass surface (single-pane safety glass) with matt style (sand-blasted)



Groove 39



Groove 44



Groove 49



Groove 50

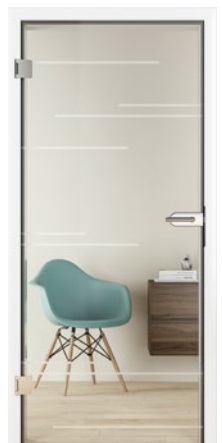

GrooveGlass 50
Clear glass surface (single-pane safety glass) with matt style (sand-blasted)

All timber doors in real lacquer, Traffic white RAL 9016



Groove 19



Groove 20



GrooveGlass 20
Clear glass surface
(single-pane safety
glass) with matt style
(V fluted glass)



GrooveGlass 20
Matt glass surface
(single-pane safety
glass, sand-blasted)
with clear style



Groove 21



GrooveGlass 29
Clear glass surface
(single-pane safety
glass) with matt style
(sand-blasted)



GrooveGlass 29 Black
.NEW
Clear glass surface
(single-pane safety
glass) with black lines
(textured lacquer)



Groove 31

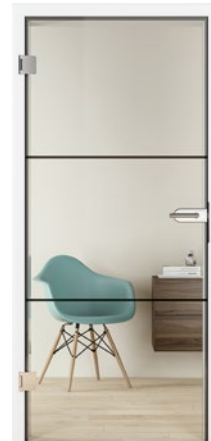

GrooveGlass 31 Black
.NEW
Clear glass surface
(single-pane safety
glass) with black lines
(textured lacquer)



Groove 34



GrooveGlass 50 Black
.NEW
Clear glass surface
(single-pane safety
glass) with black lines
(textured lacquer)



Groove 51



GrooveGlass 51
Matt glass surface
(single-pane safety
glass, silkscreen)
with clear style



Groove 53



Groove 54



Groove 56



Groove 78



Groove 85



GrooveGlass 85
Matt glass surface
(single-pane safety
glass, sand-blasted)
with clear style



Groove 88



Groove 89



Groove 92



Groove 95
.NEW



Groove 101
.NEW



Groove 102
.NEW



Groove 103
.NEW



Groove 104
.NEW



Groove 107
.NEW

All timber doors in real lacquer, Traffic white RAL 9016

RIGHT. Rebated timber door DesignLine Groove 107, real lacquer Traffic white RAL 9016, lever handle Linea matt stainless steel







DesignLine Steel

DesignLine Plain

STEEL. The Steel style represents a modern design thanks to the surface-mounted embellishments in a stainless steel look.





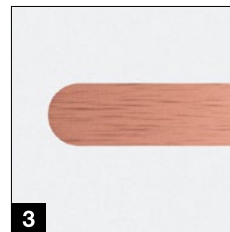
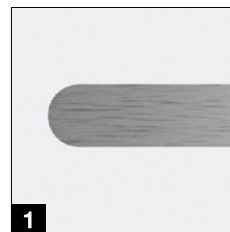

PLAIN. The Plain style creates elegant accents with inlaid and thus flush-fitting embellishments. For a modern and exclusive door design, you can choose from embellishments in 4 looks: stainless steel **1**, black **2**, bronze **3** or gold **4**.

Door versions

-  Rebated with rounded edges
-  Rebated with angular edges
-  Flush



Duradecor smooth

-  White lacquer RAL 9016
-  White Parchment
-  Light grey RAL 7035
-  Dusty grey RAL 7037
-  White Ash
-  French Beech













Ultra matt (only for DesignLine Steel)

-  White
-  Taupe
-  Dusty grey
-  Anthracite grey
-  Black .NEW









Duradecor texture

-  Grey Oak
-  Wild Oak
-  Brushed White
-  Brushed Pine
-  Brushed Salted Oak
-  Brushed Larch, light .NEW
-  Brushed Larch, dark .NEW
-  Alpine Oak .NEW
-  North Oak .NEW
-  Natural Oak .NEW



Real lacquer / real lacquer matt

-  Traffic white RAL 9016
-  Pure white RAL 9010
-  Light grey RAL 7035
-  Taupe RAL 7048
-  Dusty grey RAL 7037
-  Anthracite grey RAL 7016
-  Jet black RAL 9005



Choice of RAL
(not for real lacquer matt)

→ Further information about the surface finishes, colours and decors can be found in the ProLine section starting on page 19.

LEFT. Flush-closing timber door DesignLine Plain 27 – 7, Duradecor White lacquer, black embellishments, contrasting edge 4Protect in black, lever handle Linea black.edition



Steel 14 / Plain 14 – 7



Steel 16



Steel 20



Steel 23 / Plain 23 – 7



Steel 27 / Plain 27 – 7



Steel 29



Steel 37



Steel 38



Steel 39



Steel 78



Plain 27 – 7
With black embellishments, door fittings
black.edition



Matching glass door
Loft design 1 – 5
Clear glass surface
(single-pane safety glass) with black lines
(textured lacquer)

All timber doors in Duradecor, White lacquer RAL 9016

RIGHT. Rebated timber door DesignLine Plain 23 – 7,
real lacquer Traffic white RAL 9016, bronze embellishments,
lever handle Bi-colour System 162 matt white / bronze, concealed hinges





DesignLine Rail

RAIL. We recommend the timber and glass combination as the perfect complement to the DesignLine timber door styles.

→ Further information about the surface finishes, colours and decors can be found in the ProLine section starting on page 19.





**Rail 1
Clear glass**
Available in the glass types Clear and Clear white

**Rail 2
Matt glass**
Available in the glass types Satinato and silkscreen, solid

































**Rail 1
Design glass**
Available in the glass styles Wave, Gropus matt, Gropus clear, Gisa, Jil, Raff, GrooveGlass 15 clear / matt (shown), GrooveGlass 29 clear / matt

→ Further information on the glass types can be found in the GlassLine section starting on page 61.

Door versions

-  Rebated with rounded edges
-  Rebated with angular edges
-  Flush



-  **Duradecor smooth**
 -  White lacquer RAL 9016
 -  White Parchment
 -  Light grey RAL 7035
 -  Dusty grey RAL 7037
 -  White Ash
 -  French Beech
-  **Ultra matt**
(only for DesignLine Steel)
 -  White
 -  Taupe
 -  Dusty grey
 -  Anthracite grey
 -  Black .NEW
-  **Duradecor texture**
 -  Grey Oak
 -  Wild Oak
 -  Brushed White
 -  Brushed Pine
 -  Brushed Salted Oak
 -  Brushed Larch, light .NEW
 -  Brushed Larch, dark .NEW
 -  Alpine Oak .NEW
 -  North Oak .NEW
 -  Natural Oak .NEW
-  **Real lacquer / real lacquer matt**
 -  Traffic white RAL 9016
 -  Pure white RAL 9010
 -  Light grey RAL 7035
 -  Taupe RAL 7048
 -  Dusty grey RAL 7037
 -  Anthracite grey RAL 7016
 -  Jet black RAL 9005
-  Choice of RAL
(not for real lacquer matt)

All doors in Duradecor, White lacquer RAL 9016

LEFT. Rebated timber glass door Rail 1, design glass GrooveGlass 15 clear / matt, Duradecor White lacquer, lever handle Linea matt stainless steel



ClassicLine Carolina









The panel frames are created by embossed profiling in the door leaf. The high-quality lacquer coating means you can enjoy a smooth, vibrant colour surface. These especially cost-effective designs in a classic style are only available in our standard sizes.



→ Further information about the surface finishes, colours and decors can be found in the ProLine section starting on page 19.

Door versions

-  Rebated with rounded edges

-  **Real lacquer / real lacquer matt**
-  Traffic white RAL 9016
-  Pure white RAL 9010
-  Light grey RAL 7035
-  Taupe RAL 7048
-  Dusty grey RAL 7037
-  Anthracite grey RAL 7016
-  Jet black RAL 9005
-  Choice of RAL (not for real lacquer matt)



Carolina 1



Carolina 1
With glazing cut-out Lugano



Carolina 2



Carolina 2
With glazing cut-out LA 2



Carolina 4



Carolina 4
With glazing cut-out LA rail 2/3



Carolina 5

All doors in lacquer, Traffic white RAL 9016

LEFT. Rebated timber door ClassicLine Carolina 1, real lacquer Traffic white RAL 9016, lever handle Linea matt stainless steel





ClassicLine Georgia

The high-quality profile strip is inlaid into grooves in the door leaf using traditional carpentry techniques, lending these styles a very elegant appearance that is the perfect match for classic interiors.







→ Further information about the surface finishes, colours and decors can be found in the ProLine section starting on page 19.

Door versions

-  Rebated with rounded edges
-  Rebated with angular edges
-  Flush







Duradecor smooth

-  White lacquer RAL 9016
-  White Parchment
-  Light grey RAL 7035
-  Dusty grey RAL 7037
-  White Ash
-  French Beech







Duradecor texture

-  Grey Oak
-  Wild Oak
-  Brushed White
-  Brushed Pine
-  Brushed Salted Oak



Real lacquer / real lacquer matt

-  Traffic white RAL 9016
-  Pure white RAL 9010
-  Light grey RAL 7035
-  Taupe RAL 7048
-  Dusty grey RAL 7037
-  Anthracite grey RAL 7016
-  Jet black RAL 9005
-  Choice of RAL (not for real lacquer matt)



Georgia 1



Georgia 2
With glazing cut-out



Georgia 3



Georgia 4



Georgia 4
With glazing cut-out



Georgia 5

All doors in lacquer, Traffic white RAL 9016

LEFT. Rebated timber door ClassicLine Georgia 2, real lacquer Taupe RAL 7048, lever handle Vallis matt stainless steel













ClassicLine Montana

The high-quality finish of the frame look emphasises the simple elegance. The pared-back design suits both classic and modern interiors.

→ Further information about the surface finishes, colours and decors can be found in the ProLine section starting on page 19.



Door versions

-  Rebated with angular edges
-  **Real lacquer / real lacquer matt**
-  Traffic white RAL 9016
-  Pure white RAL 9010
-  Light grey RAL 7035
-  Taupe RAL 7048
-  Dusty grey RAL 7037
-  Anthracite grey RAL 7016
-  Jet black RAL 9005
-  Choice of RAL (not for real lacquer matt)



Montana 1
With glazing cut-out



Montana 2



Montana 3



Montana 4
With glazing cut-out



Montana 5



Montana 6
With glazing cut-out

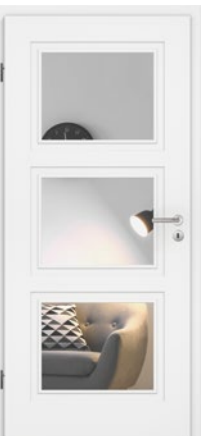

Montana 7
With glazing cut-out



Montana 8

All doors in lacquer, Traffic white RAL 9016

LEFT: Rebated timber door ClassicLine Montana 4, real lacquer Traffic white RAL 9016, lever handle Linea black.edition













ClassicLine Kontura

The contour-milled profiles and slight V-groove lend the 46 mm-thick door leaf a particular charm, making it blend in perfectly with modern and period properties alike.

→ Further information about the surface finishes, colours and decors can be found in the ProLine section starting on page 19.



Door versions

-  Rebated with rounded edges
-  **Real lacquer / real lacquer matt**
-  Traffic white RAL 9016
-  Pure white RAL 9010
-  Light grey RAL 7035
-  Taupe RAL 7048
-  Dusty grey RAL 7037
-  Anthracite grey RAL 7016
-  Jet black RAL 9005
-  Choice of RAL (not for real lacquer matt)

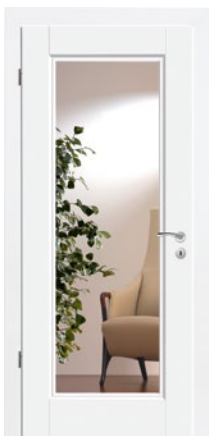

Kontura 1
With glazing cut-out
LA 2 1



Kontura 2



Kontura 3
With glazing cut-out LA



Kontura 4
Rail 1 / 3



Kontura 5



Kontura 6
With glazing cut-out
LA 2



Kontura 7



Kontura 12

All doors in lacquer, Traffic white RAL 9016

LEFT: Rebated timber door ClassicLine Kontura 4, real lacquer Jet black RAL 9005, lever handle Linea matt stainless steel



GlassLine

MORE LIGHT FOR YOUR HOME. GlassLine doors offer you many clear advantages. Glass doors are elegant and chic. They give your home an open feeling and lend each room a very special charm. GlassLine is also particularly easy to clean: all the styles with sand-blasted glass feature nano coating – so you benefit from fewer fingerprints!



Laser technique
This glass finish offers fine details and shading. The depth effect creates fascinating impressions that are further enhanced by the brilliance of the glass door.



Sand-blasting
For those who value individuality, the sandblasting technique draws delicate designs in the glass surface. The matt surface finish with nano coating guarantees fewer fingerprints.



Silkscreen
Design meets superior surface finishing: the highly scratch-resistant surface is easy to clean and resistant to soiling.



Fluted glass
The fluted glass on the glass door is created by a fine V-groove. A clear or satin-finished glass is used depending on the preferred opaqueness. The fluted glass impresses with special patterns, its tactile feel and the extraordinary play of light produced by the prism effect.

Tip Fewer fingerprints thanks to nano coating

Tip Particularly easy to clean



Glass type Clear
With this glass type, the glass door creates a subtle, interesting contrast. The iron oxide in the glass produces a slight “green shimmer”.



Glass type Clear White
The Clear White glass type creates an almost colour-neutral transparency.



Single-pane safety glass
All glass doors with styles feature 8 mm-thick single-pane safety glass. This glass type is also available in tinted or solid matt versions, as well as in a cool loft design.

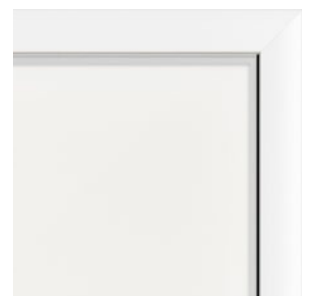

Laminated safety glass
This 10 mm-thick glass type consists of 2 panes that are firmly connected with a colour or matt plastic film.

LEFT. Glass door Gropus , fitting set Aronda Combi, matt stainless steel, lever handle Linea matt stainless steel



Agesa
Clear glass surface (single-pane safety glass) with matt style (laser technology)



Gropus
Clear glass surface (single-pane safety glass) with style (fluted glass)



Gropus
Matt glass surface (single-pane safety glass, Satinato) with style (fluted glass)



Jada
Clear glass surface (single-pane safety glass) with matt style (sand-blasted)



Jil
Clear glass surface (single-pane safety glass) with matt style (sand-blasted)



Jil
Matt glass surface (single-pane safety glass, sand-blasted) with clear style



Liko
Clear glass surface (single-pane safety glass) with matt style (sand-blasted)



Liko
Matt glass surface (single-pane safety glass, sand-blasted) with clear style



Privat
Matt glass surface (single-pane safety glass, sand-blasted) with clear style as desired



Raff
Clear glass surface (single-pane safety glass, sandblasting, optionally in silkscreen) with matt style



Raff
Matt glass surface (single-pane safety glass, sand-blasted) with clear style



Wave
Clear glass surface (single-pane safety glass) with matt style (sand-blasted)



Wave
Matt glass surface (single-pane safety glass, sand-blasted, optionally in silkscreen) with clear style



Slate
Clear glass surface (single-pane safety glass) with digital print motif in Black, Anthracite grey, Dusty grey, Taupe or White (shown)



Linen
Clear glass surface (single-pane safety glass) with digital print motif in Black, Anthracite grey, Dusty grey, Taupe or White (shown)



Clear
Clear glass surface
(single-pane safety glass
or laminated safety glass
with plastic film inside)



Clear bronze
Tinted glass surface
(single-pane safety glass)



Clear grey
Tinted glass surface
(single-pane safety glass)



Dark grey
Tinted glass surface
(single-pane safety glass)



Master-Carré
Glass surface
(single-pane safety
glass, Master-Carré)



Solid silkscreen
Solid matt glass surface
(single-pane safety glass,
silkscreen)



Satinato
Matt glass surface (single-
pane safety glass, Satinato)



Satinato look
Matt glass surface
(laminated safety glass
with plastic film inside)



White
Glass surface (laminated
safety glass) with coloured
plastic film inside



Black
Glass surface (laminated
safety glass) with coloured
plastic film inside



Loft design 1 - 1 .NEW
Clear glass surface
(single-pane safety glass)
with black edge



Loft design 1 - 5
Clear glass surface
(single-pane safety glass)
with black lines



Loft design 2 - 5
Clear glass surface
(single-pane safety glass)
with black lines



Loft design 3 - 5 .NEW
Clear glass surface
(single-pane safety glass)
with black lines



Loft design 1 - 1 .NEW
Matt glass surface
(Satinato) with black edge



Loft design 1 - 5 .NEW
Matt glass surface
(Satinato) with black lines



Loft design 2 - 5 .NEW
Matt glass surface
(Satinato) with black lines



Loft design 3 - 5 .NEW
Matt glass surface
(Satinato) with black lines



Loft design 1 - 1 .NEW
Tinted glass surface Clear
grey (single-pane safety
glass) with black edge



Loft design 1 - 5 .NEW
Tinted glass surface Clear
grey (single-pane safety
glass) with black lines



Loft design 2 - 5 .NEW
Tinted glass surface Clear
grey (single-pane safety
glass) with black lines



Loft design 3 - 5 .NEW
Tinted glass surface Clear
grey (single-pane safety
glass) with black lines

RIGHT. Glass door loft design 2 - 5, fitting set Purista Combi black.edition, lever handle Linea black.edition, sliding door Slide Compact with glazed side element, profile black.edition, recessed handle 6402 black.edition





Steel loft doors

INDUSTRIAL STYLE FOR LIVING SPACES AND WORKSPACES. Do you value timeless elegance and modern minimalism? If so, our loft doors are perfect for you. The harmonious balance of steel and glass gives your interior design a special touch. The loft doors are available up to a door set size of 5000 × 4000 mm! Doors in this size are also very elegant thanks to their narrow profile view of 76 mm (door) and 20 mm (fixed glazing) and the surface-mounted rails.

You can optionally equip the doors with angled glazing beads or the Slim glazing bead. Choose between Jet black RAL 9005 or stainless steel for your door fittings.



TOP. Profile with glazing bead Slim (standard), viewed width 15 mm

CENTRE. Profile with angled glazing bead (optional), viewed width 50 mm

BOTTOM. Lever handle in Jet black RAL 9005

LEFT. Double-leaf steel loft door with transom light, Jet black RAL 9005, angled glazing beads, lever handle Ogro design model 8155 V, Jet black RAL 9005



TIMELESS DESIGN. With loft doors, you can create a modern, subtle connection between multiple rooms, while also providing them with plenty of light. The filigree steel profile gives the design a modern line and a light appearance, while the glass adds to this overall elegant effect.





TOP LEFT. Double-leaf hinged door with optional rails

TOP RIGHT. Single-leaf hinged door with side elements, transom light and optional rails

BOTTOM. Double-leaf sliding door with side elements

Sliding doors

TIMBER SLIDING DOOR FRAMES. Our single-leaf and double-leaf room solutions open up new possibilities for making ideal use of your living space. When fitted in front of the wall, the door leaf slides on two tracks mounted in the sliding door box. Timber sliding door frames are available in door version type A, B or C with vertical stop. Frame, sliding door box and door leaf with Duradecor ultra matt, slate, linen and real lacquer or real wood veneer surface finish create a harmonious whole. When fitted running within the wall, the tracks are fitted in an on-site door pocket in the wall. This eliminates the need for a sliding door box.

→ For further information, see page 100 onwards.

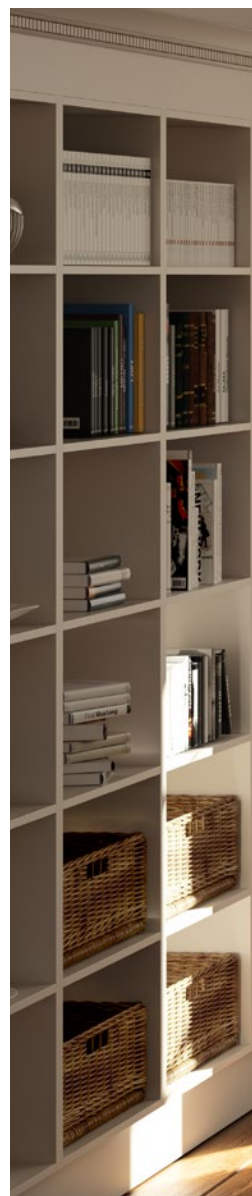

Timber sliding door frame versions running in front of the wall



Double-leaf sliding door, type A, running in front of the wall



Single-leaf sliding door, type B, running in front of the wall



Single-leaf sliding door, type C with vertical stop, running in front of the wall

LEFT. Timber frame type C with vertical stop, running in front of the wall, Duradecor textured Grey oak, bar handle Basic round stainless steel

BOTTOM. Timber frame type C, running in front of the wall, door leaf ClassicLine Georgia 1 Duradecor White lacquer, bar handle Basic round stainless steel





STEEL SLIDING DOOR FRAMES. The complete door set with vertical stop can be fitted in front of or running within the wall. The robust frames are supplied with a high-quality powder coating. For fitting in partition walls, we recommend the version with box design. The entire sliding door system is fitted as a unit and only has to be cladded with gypsum board. Especially elegant in version HW-SL with a frame depth of only 6 mm (shown, top).





LEFT. Steel frame HW-SL in box design, running in the wall, door leaf ProLine Duradecor Slate, Traffic white RAL 9016, bar handle Basic angular stainless steel

BOTTOM. Steel frame, running in front of the wall, door leaf ProLine Duradecor White lacquer, bar handle Basic round stainless steel



SLIDING DOOR SYSTEM CORVARA. NEW.

With its striking castors and stylish track profile, the Corvara sliding door system reinterprets industrial style. Matching accessories such as the flat handle in black.edition emphasise the exclusive feel.



TOP LEFT. Corvara sliding door, Duradecor Wild Oak horizontal door leaf, Flat handle black.edition



TOP RIGHT. Slide Compact sliding door with glazed side element profile black.edition, Clear grey door leaf, Flat handle black.edition, fitting in the reveal

BOTTOM RIGHT. Slide Compact sliding door with vertical stop, GrooveGlass 85 door leaf, recessed lever handle 6402 stainless steel, fitting in front of the reveal





SLIDING DOOR SYSTEM SLIDE COMPACT. The track profile for the sliding door leaf is available in the surface finishes matt stainless steel, Jet black or White. The profile can be fitted both in front of the wall and in the reveal. With a glazed side element, the system presents a translucent, space-saving door solution for wide passages. For a door leaf weight of up to 60 kg, the Slide Compact system is equipped with a SafeClose in order to gently close the door leaves.

→ For further information, see page 100 onwards.

Special doors and frames

REVERSE-OPENING DOORS. This door version boasts a flush-fitting transition between door leaf and frame on the hallway side, while simultaneously opening through the frame into the room beyond. As with flush-closing doors, you can achieve an eye-catching door view in the hallway.

→ For further information, see page 107 onwards.





LEFT. Reverse-opening door set, flush-closing timber door with reveal rebate, real lacquer Traffic white RAL 9016, lever handle Linea matt stainless steel

RIGHT. Flush-closing timber door with Zeroline frame, real lacquer Traffic white RAL 9016, lever handle Linea Black matt

ZEROLINE FRAME. The Hörmann Zeroline frame is the perfect choice for all connoisseurs of clear design language. The cleverly conceived structure captivates with a minimalist design that enables a flush-fitting wall and door leaf and features a virtually invisible frame construction owing to a frame depth of just 2 mm, plus concealed hinges. The result is a door / frame combination that meets even the most exacting design demands.

→ For further information, see page 106 onwards.

Function and construction project doors

TIMBER CONSTRUCTION PROJECT DOORS. For all requirements in commercial and residential construction, our timber doors can be equipped with additional functions such as fire protection, security or acoustic insulation. Doors are especially exposed to stress in schools, nurseries, offices and hotels. To meet these demands, we have developed our new premium-quality DuraProject door surface finish that offers the same product properties as an HPL surface.

→ For further information, see page 110 onwards.

RIGHT. Flush-closing timber door, DuraProject White lacquer, lever handle Lucia Professional

BOTTOM. Flush-closing timber door, DuraProject Dusty grey, lever handle Lucia Professional





Functions at a glance



Fire and smoke protection

Fire protection can save lives! A suitably equipped door can protect against penetrating flames (for at least 30 or 90 minutes) as well as prevent the penetration of dangerous combustion gases. Fire-rated / smoke-tight door sets are only available as a complete package which includes the frame and all door fittings.



Acoustic insulation

Acoustic-rated doors are in demand in places where it can be very loud in apartments or offices. The connection between the door and frame is crucial here. It is an essential component for guaranteeing the required acoustic insulation.



Security

Suitable special functions can significantly reduce the risk of burglary. Hörmann recommends resistance class RC 2 or, even better, RC 3 for apartment entrance doors.



Climatic class 3

Doors in this class feature a special door leaf construction that balances the temperature and moisture differences between rooms with different uses, such as between an unheated cellar and a warm hallway.









CLIMATE AND APARTMENT ENTRANCE DOORS.

For multiple-occupancy dwellings, our doors offer high acoustic insulation levels, a reliable function even when temperatures in the hallway differ from those inside the rooms, plus certified security. Choose from three equipment packages for added security and convenience.

→ For further information, see page 110 onwards.

Climate and apartment entrance doors

	WET system 1*	WET system 2	WET system 3
 Climatic class 3	●	●	●
 Acoustic rating category 1	●		
 Acoustic rating category 2		●	
 Acoustic rating category 3		●	●
 RC2 security features		○	○
 RC3 security features			●

● = Standard equipment ○ = Optional equipment

*) only ProLine



GARAGE CONNECTING DOORS. NEW. Fire protection of at least 30 minutes is required by law at the point where the garage transitions to the living area. The standard smoke protection offers protection from exhaust fumes and the optional acoustic insulation function helps block out intrusive engine noise. The garage connecting door is equipped with RC2 security features as standard. The optional RC3 equipment provides extra security.

→ For further information, see page 110 onwards.

LEFT. Rebated apartment entrance door
WET 3 ProLine, Duradecor White lacquer,
protective fitting matt stainless steel

BOTTOM. Rebated garage connecting door,
Duradecor White lacquer, lever handle
Linea matt stainless steel



Zubehör

DOOR OPERATOR PORTAMATIC. Open and close your residential internal doors easily and automatically via a hand transmitter or button. Whether you are physically disabled or would simply like more convenience, this technology is sure to make your everyday life easier. The door operator PortaMatic not only features an array of functions and settings but also minimal power consumption. In addition, the PortaMatic is up to 25% cheaper than similar door operators and can be subsidised up to 100% by your nursing care insurance.



Find out more about support options at www.hormann.co.uk/home-owners-and-renovators/operators/internal-door-operators





DOOR LOCK OPERATOR SMARTKEY. Easily open your door lock with the press of a button using your hand transmitter, radio internal push button or directly via the sensor field on the SmartKey. So there's no need to put down your shopping in order to open your door. Even with a walker, wheelchair or pram, it is much easier to enter your house or apartment because you can open the door from a distance. Locking takes place either by pressing a button or automatically after a specified period of time. This securely locks your door and provides the greatest possible protection against burglary.

→ Further information can be found on page 111.



86



90



100



Design. Equipment. Accessories.

- 86 Door and frame design
- 88 Door fittings
- 90 Door fittings black.edition
- 91 Lever handle sets for timber doors
- 96 Door fittings and lever handle sets for glass doors
- 98 Glazing cut-outs, side elements, transom lights
- 100 Door fittings and lever handle sets for sliding doors
- 102 Door and frame types
- 105 Steel frame VarioFix
- 106 ZeroLine frame
- 107 Reverse timber door
- 108 Overview table
- 110 Function and construction project doors
- 112 Dimensions and fitting data

Door and frame design*

Premium carpenter quality for high demands



Attractive appearance with precision-fit and installation-friendly corner joints 1

Jamb lining

- Screwed corner joints with jamb lining connection
- Easily readjustable
- Strong friction locking

Cladding

- Solid-metal screw connectors
- Excellent friction locking
- Direct pressure distribution on the connection surfaces
- No visible drilled holes in the cladding

High form stability thanks to the robust frame construction 2

- Jamb lining 25 mm thick
- Jamb lining with Duradecor surface finish
- Melamine-coated backing
- Claddings made of MDF

A Edge radius 3 mm

B Wall edges
16 mm
23 mm (optional)

C Cladding widths
60 mm
70 mm (optional in Duradecor White lacquer)
80 mm

*) in ProLine, DesignLine, ClassicLine and GlassLine versions

Permanently quiet closing thanks to a high-quality seal ³

- Two-chamber system
- Clean contact with the door leaf
- Good absorbing properties

Robust standard lock plate for added security ⁴

- Movable backfill
- Secured with 6 screws
- Double-turn closing cycle
- Retrofit kits available

Hybrid hinge pocket prevents lowering of the door ⁵

- Carrying capacity 80 kg
- Reinforced metal plastic mount
- Secured in jamb lining with 4 screws
- Guiding sleeves extending to front edge of cladding
- For timber and glass doors

High stability thanks to door leaf with frame construction ⁶

- Internal doors with 70 mm frame construction
- On hinge side and lock side

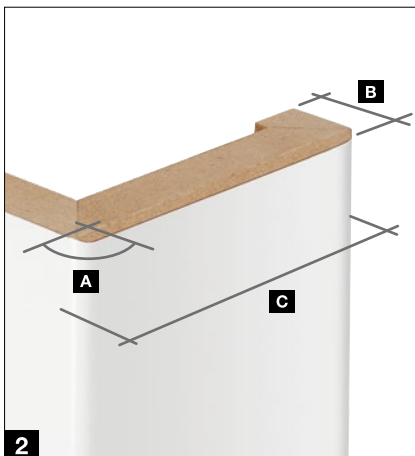

Door fittings

For rebated door leaves

Door fittings for rebated door leaves



Deadlock, Class I, lock cover in nickel silver (as standard)



2-part hinge V 3420 WF (as standard)



2-part hinge V 3420 WF black.edition in Jet black (optional)



3-part hinge V 4426 WF (optional)



3-part hinge V 4426 WF black.edition in Jet black (optional)



3-way adjustable hinge VX 160 – 18 (optional)



Concealed hinge Pivota FX 2 60 3D (optional)

Door fittings for flush-closing door leaves



Deadlock, Class I, lock cover in nickel silver (as standard)



Magnetic catch lock to gently and quietly close the door (optional)



Magnetic catch lock black.edition to gently and quietly close the door (optional)



Magnet catch lock with short lock cover for a discreet door view (optional)



Euro hinge concealed 3-way AN (optional)



Concealed 3-way adjustable hinge DX 61 (optional)



Magnet catch lock black.edition with short lock cover for a discreet door view (optional)



Euro hinge concealed 3-way AN black.edition in Jet black (optional)



Concealed 3-way adjustable hinge DX 61 in Jet black (optional) .NEW

Door fittings black.edition

In elegant Jet black

For design lovers, we recommend the door fittings in elegant Jet black. In contrast with white or grey surface finishes, our **black.edition** gives your door an exclusive touch.

Only from Hörmann

All door fittings
in black.edition

4Protect contrasting edge

→ For further information, see page 103 onwards.

Frame seal

Door hinges

→ For further information, see page 88 onwards.

Lever handle set

→ For further information, see page 91 onwards.

Lock plate and lock cover

→ For further information, see page 88 onwards.

Sliding door fittings



Glass door fittings



→ For further information, see page 100 onwards.



Lever handle sets

For timber doors



Euro round lever handle .NEW
Matt stainless steel



Euro round lever handle .NEW
Matt stainless steel with Fastlock



Euro round lever handle .NEW
Jet black matt



Euro round lever handle .NEW
Jet black matt with Fastlock



Euro angular lever handle .NEW
Matt stainless steel



Euro angular lever handle .NEW
Matt stainless steel with Fastlock



Euro angular lever handle .NEW
Jet black matt



Euro angular lever handle .NEW
Jet black matt with Fastlock



Fastlock locking

For a minimalist door view, we supply this lever handle series without a drilled key hole and without a locking option as standard. For an additional charge, all models are also available with Fastlock locking. This locking mechanism is elegantly integrated into the lever handle and can easily be locked and unlocked with one hand.

Lever handle sets

For timber doors



Ala
Matt stainless steel
S P



Area .NEW
Matt stainless steel
S P



Area .NEW
Jet black matt
S P



Apart
Matt stainless steel
S P



Basica 2
Matt stainless steel
S P



Cuneus .NEW
Jet black matt
S P



Dee
Matt stainless steel
S P



Dee
Matt stainless steel
S



Indra
Polished stainless steel
matt
S F



Karee
Matt stainless steel
S

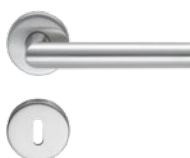

Linea
Matt stainless steel
S F P



Linea
Polished stainless steel
F

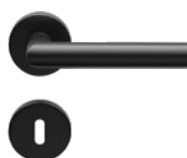

Linea black.edition
Jet black matt
S F P

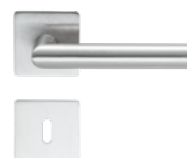

Linea
Matt stainless steel
S F



Luba
Matt stainless steel
S P

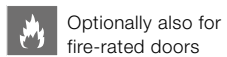



Basica 3
Matt stainless steel
S P



Cuneus .NEW
Matt stainless steel
S P



Karee black.edition
Jet black matt
S F



Lilet
Polished stainless steel,
White porcelain handle
S



Vallis
Matt stainless steel
S P



Vento
Matt stainless steel
S P

Variants for lever handle and lock rose escutcheons

Lever handle and lock sets are a defining element for the overall appearance of your residential internal door. Hörmann offers different variants of the lever handle sets shown:

S STANDARD ROSE ESCUTCHEON. The approx. 10 mm-thick lever handle and lock rose escutcheons are surface-mounted on the door leaf.

F FLAT ROSE ESCUTCHEON. This flat rose escutcheon shape adds just 3 mm, resulting in an elegant door view.

P PLANAR. Perfectly inset in the door leaf, the fully flush-fitting Planar rose escutcheons are especially impressive for fans of design.

Another fine detail is the omission of the drilled key hole, allowing the design the look even more minimalistic and therefore more elegant.



Lever handle sets

For timber doors

Bi-colour system 162



Matt black / matt bronze

F



Matt black / matt gold

F

Bi-colour system 250



Matt black / matt bronze

F



Matt black / matt gold

F

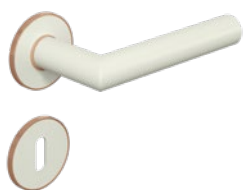

Matt white / matt bronze

F

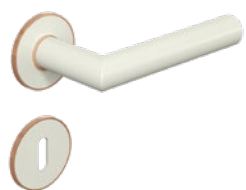

Matt white / matt gold

F

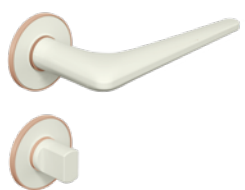

Matt white / matt bronze

F



Matt white / matt gold

F



Anthracite / matt stainless steel

F



Anthracite / matt stainless steel

F

The **F** flat rose escutcheon variant adds just 3 mm, resulting in an elegant door view. Further information can be found on page 93.



Bi-colour lever handle sets

Customise your timber doors even more with our Bi-colour system lever handles. Colour lever handles are combined with rose escutcheons for an elegant contrasting look. An unusual design element setting fine accents.



Leaf Light

Cashmere grey (shown) or stainless steel, matt

S



Remote

Cashmere grey (shown) or stainless steel, matt

S



Avus One

Cashmere grey (shown) or stainless steel, matt, no rose escutcheon, optionally with Smart2Lock door lock on the handle

S

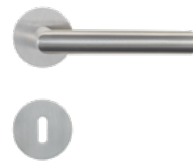

Lucia

Stainless steel matt (shown) or Jet black matt (only Lucia Professional), optionally with Smart2Lock for locking the door at the handle

S Lucia Professional

F Lucia PiattaS

S Standard rose escutcheon

F Flat rose escutcheon

Further information can be found on page 93.



Smart2Lock lock

The locking mechanism is elegantly integrated into the lever handle and can be locked and unlocked with one hand. When locked, the lever handle can no longer be pressed down from outside or inside. Thanks to this intelligent locking technology, the key rose escutcheon is no longer necessary, giving your residential internal door an even more minimalist, elegant look. This lock is available as an option for the Avus One and Lucia models.

Door fittings and lever handle sets

For glass doors



Linea
Matt stainless steel,
polished stainless steel or EV 1



Basica 3
Matt stainless steel or EV1



Apart
Matt stainless steel or polished /
matt stainless steel



Dee
Matt stainless steel,
polished stainless steel or EV1



Aronda Combi fitting set
Matt stainless steel,
polished stainless steel or EV1



Purista Combi fitting set
Matt stainless steel,
polished stainless steel or EV1



Conica Combi fitting set
Matt stainless steel or EV1



Mina Combi fitting set
Matt stainless steel, special
glass door version required



Linea, black.edition
Jet black matt



Karee, black.edition
Jet black matt



**Purista Combi fitting set,
black.edition**
Matt Jet black incl. magnetic
catch lock



Increased acoustic insulation

Do you want quiet, bright living spaces and workspaces? Then we recommend the optional equipment for revolving glass doors Clear and Satinato with 11 mm laminated safety glass and retractable bottom seal. Experience doors with an acoustic insulation value of up to 32 dB (corresponding to acoustic rating category SK 1).



Smart2Lock lock

The locking mechanism is elegantly integrated into the door fitting and can be locked and unlocked with one hand. When locked, the lever handle can no longer be pressed down from outside or inside. Thanks to this intelligent locking technology, glass doors can be locked without a key.

Puristo S fitting set

Cashmere grey (shown) or stainless steel, optionally with Smart2Lock for locking the door at the handle



Avus One

Cashmere grey (shown) or stainless steel



Leaf Light

Cashmere grey (shown) or stainless steel



Remote

Cashmere grey (shown) or stainless steel

Double-action door hinges .NEW



Agita

Matt stainless steel, with pneumatic closing function, maximum door leaf weight 60 kg



Agita black.edition

Jet black RAL 9005, with pneumatic closing function, maximum door leaf weight 60 kg



Agita.Ultra

Matt stainless steel, with hydraulic closing function and adjustable closing speed, maximum door leaf weight 100 kg



Agita Ultra black.edition

Jet black RAL 9005, with hydraulic closing function and adjustable closing speed, max. door leaf weight 100 kg



Double-action door hinges .NEW

Double-action door hinges are also available as options for all glass doors. This allows the door to be opened from both sides – a highly practical option in areas where space is at a premium. The double-action door hinges can be fitted in the passage frame or directly on the brickwork.

Glazing cut-outs, side elements, transom lights

For timber doors

Glazing cut-outs for timber doors ProLine



DIN

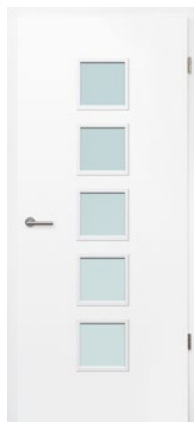

LA 5

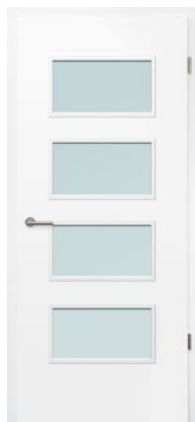

LA 9

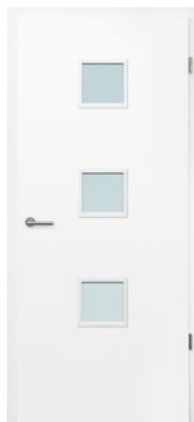

LA 10

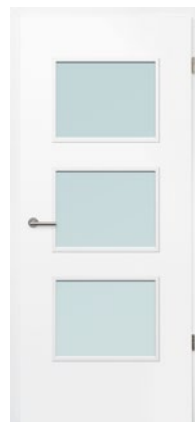

LA 11



LA 24 centre



LA 27



LA Pure

Side elements (intel-high)



Single-leaf, 1 side element



Single-leaf, 2 side elements

Transom lights (ceiling-high)

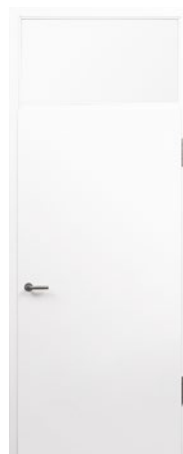

Single-leaf, 1 top part,
alternatively also with
transom light



Double-leaf, 1 transom light

Glazings for glazing cut-outs

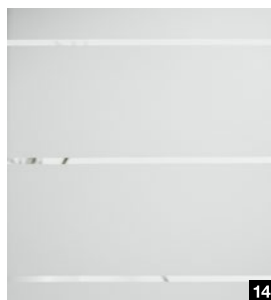
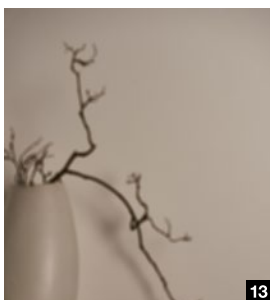
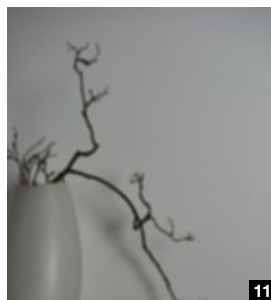
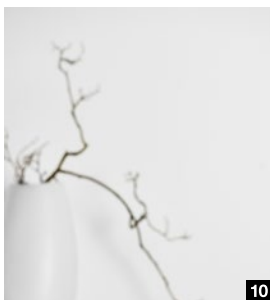
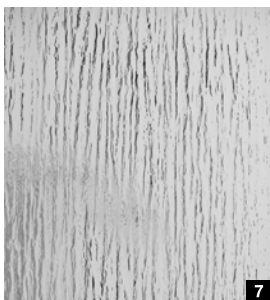
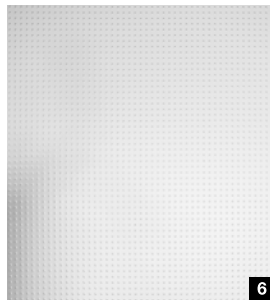
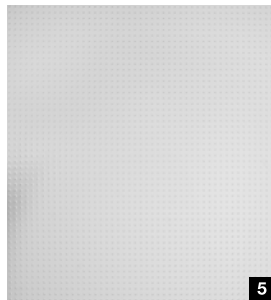
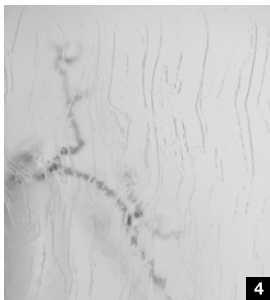
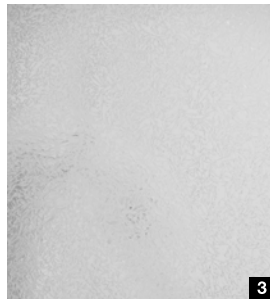
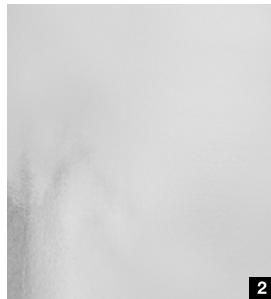
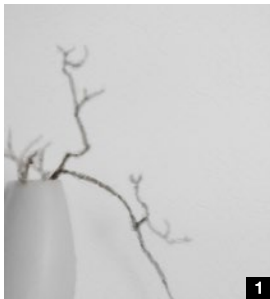

Glass types

- 1 Artista clear
- 2 Chinchilla white
- 3 Frost flower glass white
- 4 Gothic white
- 5 Pave white
- 6 Master-Carré
- 7 Silvit 178 white
- 8 Uadi white
- 9 Clear laminated safety glass
- 10 Clear white laminated safety glass
- 11 Clear grey
- 12 Dark grey
- 13 Clear bronze
- 14 GrooveGlass 15/10, clear style
- 15 GrooveGlass 15/10 matt style

Door fittings and lever handle sets

for sliding doors

Slide Compact sliding door system



The profile of the sliding door system Slide Compact is supplied as standard in matt stainless steel (shown, left) and optionally in matt Jet black (shown, centre) or White (shown, right).

Sliding door system Slide Compact with additional vertical stop (stainless steel colour) for single-leaf doors, running in front of the wall

Sliding door system in the frame



With the brush on the door leaf (shown on left) and the inlet seal in the frame (shown on right), the sliding doors with frame type C running in front of the wall offer optimum protection against odours, noise and draughts – for even more comfort in your own home.

For sliding doors running within the wall, you can use a trip handle to release a door leaf completely concealed in the wall and close the door at the push of a button.

Recessed handle for timber and glass doors

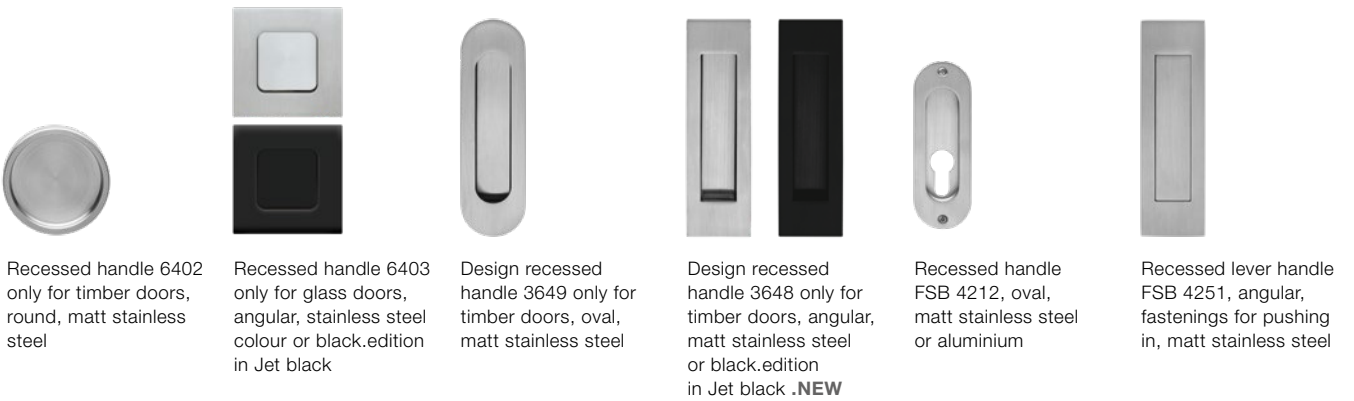

Bar handles for timber and glass doors

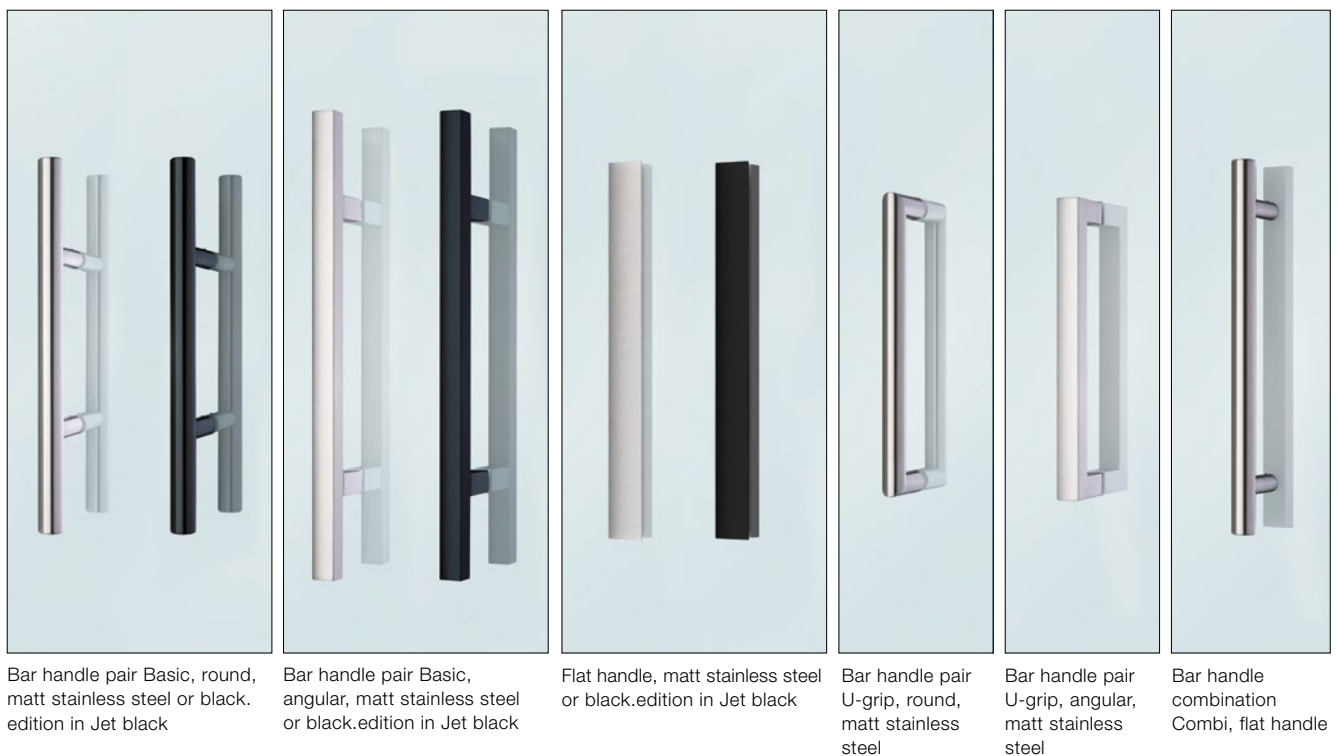

Door and frame types

Custom design and function



Rebated version with round edges

If you value a harmonious overall design, you can't go wrong with this version: The door leaf rests on the frame and has rounded door leaf edges for a harmonious appearance. The rebated door view with round edges is available for all timber doors, except DesignLine Stripe and ClassicLine Montana.

Rebated version with angular edges

If you appreciate a particularly streamlined look, then we recommend this version. The door leaf rests on the frame and has a beautifully designed, angular edge. It is available for all timber doors except for ClassicLine Carolina. In the Duradecor surface finishes with 4Protect edge guard and in the lacquer surface finish, this version boasts a perfectly seamless look.

Flush version

Are you looking for an exclusive door view in your home, with a virtually flush-fitting transition to the frame? Then we recommend a flush-closing door leaf, which harmonises particularly well with modern interior design concepts. This version is available for all timber doors with the exception of ClassicLine Carolina. In the Duradecor surface finishes with 4Protect edge guard and in the real lacquer surface finish, this version impresses with a perfect seamless look.



4Protect edge guard



4Protect edge guard

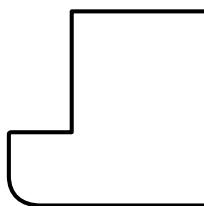

Horizontal view of door leaf

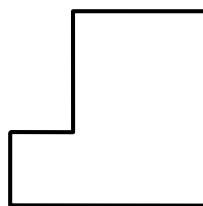

Horizontal view of door leaf



Horizontal view of door leaf



4Protect edge guard

The quadruple edge guard offers impressive features:

1. High impact resistance
2. High wear resistance
3. High scratch resistance
4. Seamless look, meaning that unlike conventional doors, no unsightly edge disturbs the high-quality door view.

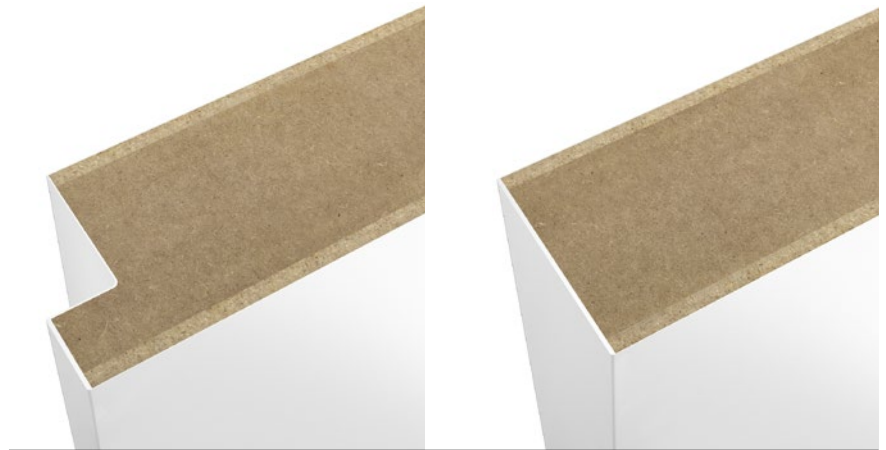

Rebated version with angular edges

Flush version

Contrasting edge 4Protect

The 4Protect contrasting edge in 6 colours gives timber doors with the Duradecor surface a special finishing touch.



Black

Anthracite

Dusty grey



White

Light grey

Taupe

Door and frame types

Custom design and function



Honeycomb insert

The honeycomb is a door inlay that retains its shape and has an excellent price-performance ratio.

Tubular chipboard spacers

The door inlay consists of individual spacers that are arranged in the best possible layout. This means the door leaf is especially sturdy and suitable for heavy wear.

Tubular chipboard plate

The solid plate with horizontal tubes gives the door leaves a high surface stability. These high-quality residential internal doors are suitable for even extremely heavy wear.

Solid chipboard

The high-quality solid chipboard door leaves have the highest leaf rigidity and are suitable for particularly heavy wear. Doors with glazing cut-outs are available with solid chipboard as standard.



Profile frame

With rounded edges

Profile frame

With angular edges
(only for lacquer surface)

Profile frame

With profiling for ClassicLine
Georgia and Carolina

Block frame

For fitting in the opening or **fascia frame** for fitting in front of the wall



90° DOOR FRAME

If you appreciate a highly linear door view, we recommend our 90° door frame. Unlike a frame with a mitre cut, the frame cladding used in this case has vertical edges. This results in a particularly harmonious look when combined with classic door styles. This option is also available with a high-quality stainless steel cover plate for flush and rebated timber doors with a brilliant real lacquer surface finish.

Steel frame VarioFix

The perfect combination of design, robustness and a long service life

High-quality design

For the steel frame VarioFix, the corner joints feature high-quality welding and a flush polish, meaning there are no visible mitre cuts in the frame corners. In flush-closing doors, the robust construction guarantees a uniform gap dimension, as the frame can no longer warp after fitting.

Ideal combination

The steel frame harmonises perfectly with other timber frames due to a frame depth of 55 mm on both sides. To match our door leaves in Duradecor White lacquer and real lacquer Traffic white, the VarioFix frame is available in Traffic white RAL 9016 with a white sealing profile or in RAL as desired. The frame can be combined with glass or timber door leaves.

Particularly long-lasting

Thanks to the high-quality powder coating, the frame can withstand run-ins with toy cars or vacuum cleaners, and any damage to the surface is easy to repair. Even cleaning water and a thorough washing cannot damage the frame.

Fast fitting

The VarioFix steel frame can be fitted to all wall types without screw fitting, using 2C foam, like a timber frame. This results in time savings of up to 50% during fitting compared with standard steel frames. Wall tolerances of up to 20 mm are no problem for the VarioFix steel frame. The adjustable decorative rebate easily compensates for different wall thicknesses during renovations and new construction projects.



ZeroLine frame .NEW

Clean design for modern living space concepts

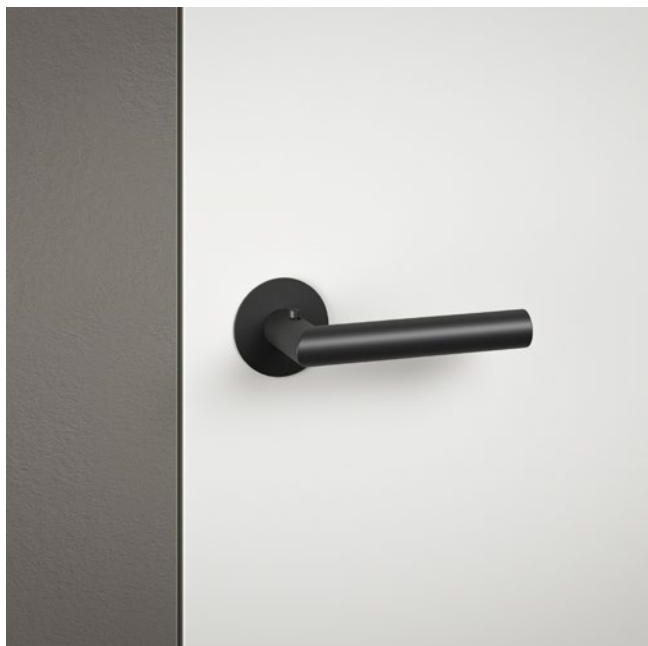

The beauty of the invisible

If you value clear design language and appreciate clean, modern design, then the Zeroline frame is the perfect choice. The minimalist appearance impresses with a flush-fitting wall and door leaf, virtually invisible frame construction owing to a frame depth of just 2 mm, plus concealed hinges. This door leaf / frame combination is a perfect fit for ambitious designs.

Frame with fabric as standard

The frame is equipped as standard with a woven fabric tape which is applied to the plaster to prevent crack formation. This completely integrates the frame into the wall.

Flush-fitting skirting boards

Skirting boards to match the frame and onto which the plaster can be directly applied are available. Skirting boards can therefore be integrated flush into the wall.

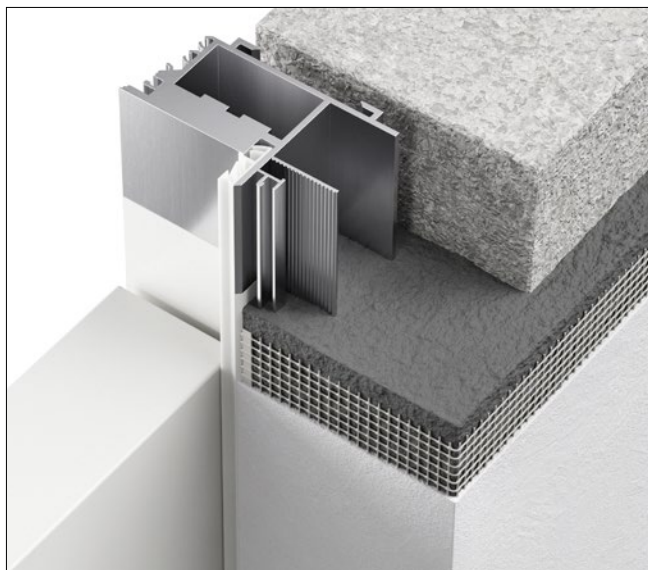

Additional use of a flexible woven fabric prevents cracks from forming in the plaster.

Equipment features

- Flush-closing door leaf
- 45 mm door leaf thickness
- Concealed hinges
- Magnetic catch lock

Nominal sizes

Max. height 2250 mm

Max. width 1250 mm

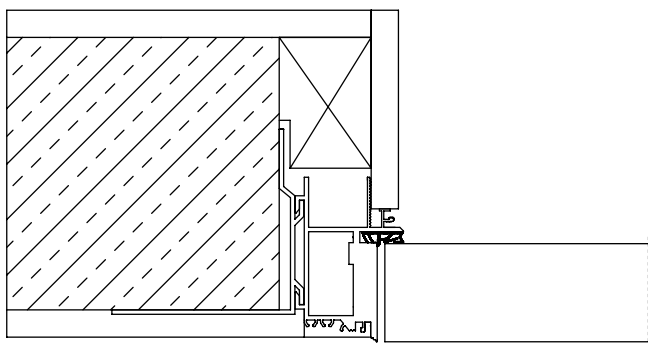

Horizontal sectional view with flush-closing door

Reverse timber door .NEW

The door has a flush-fitting view on the hallway side

Opens through the frame into the next room

If you require a matching, flush-fitting door view on the hallway side and the doors need to open through the frame into the room beyond – and not into the hallway as usual – then we recommend our reverse-opening doors (as shown, bottom right).

Elegant appearance

Concealed hinges emphasise the minimalist, modern door view.

Easy to combine

Due to the identical appearance of the door leaf and frame with flush-fitting transition, reverse-opening doors can be readily combined with flush-closing doors in the same room or hallway. This results in a harmonious and welcoming overall ambience.

Equipment features

- Flush-closing door leaf with reveal rebate
- 40 mm door leaf thickness
- Concealed hinges
- Magnetic catch lock
- Opening limiter

Nominal sizes

Max. height 2489 mm



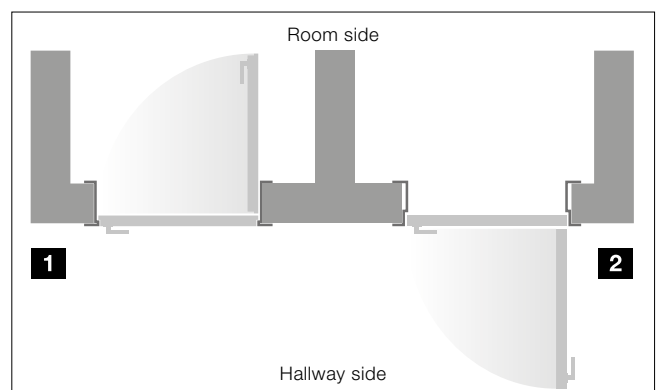



Max. width 1174 mm



The reverse-opening door (left-hand hinge) opens into the room **1** and the normally opening flush-closing door (right-hand hinge) opens into the hallway **2**.

Overview table

For timber doors

		Door styles					
		ProLine	DesignLine Stripe 15	DesignLine Groove	DesignLine Steel	DesignLine Plain	DesignLine Rail
Surfaces							
Duradecor							
Rebated angular		●	○	-	●	●	●
Rebated round		●	-	-	●	●	●
Flush angular		●	○	-	●	●	●
Duradecor texture							
Rebated angular		●	-	-	●	●	●
Rebated round		●	-	-	●	●	●
Flush angular		●	-	-	●	●	●
Ultra matt							
Rebated angular		-	-	-	●	-	-
Rebated round		-	-	-	●	-	-
Flush angular		-	-	-	●	-	-
Slate							
Rebated angular		-	-	-	●	●	-
Flush angular		-	-	-	●	●	-
Linen							
Rebated angular		-	-	-	●	●	-
Rebated round		-	-	-	●	●	-
Flush angular		-	-	-	●	●	-
Real lacquer / real lacquer matt							
Rebated angular		●	-	●	●	●	●
Rebated round		●	-	●	●	●	●
Flush angular		●	-	●	●	●	●
Real wood veneer							
Rebated angular		●	-	-	-	-	○
Flush angular		●	-	-	-	-	○

● = Available for all decors / colours ○ = Not available for all decors / colours

Door inlay

ClassicLine Carolina ClassicLine Georgia ClassicLine Montana ClassicLine Kontura







Honeycomb insert Tubular chipboard spacers Tubular chipboard plate Solid chipboard

-	●	-	-	●	●	●	●
-	●	-	-	●	●	●	●
-	●	-	-	-	-	●	●
-	○	-	-	●	●	●	●
-	○	-	-	●	●	●	●
-	○	-	-	-	-	●	●
-	-	-	-	-	-	●	●
-	-	-	-	-	-	●	●
-	-	-	-	-	-	●	●
-	-	-	-	-	-	●	●
-	-	-	-	-	-	●	●
-	-	-	-	-	-	●	●
-	-	-	-	-	-	●	●
-	-	-	-	-	-	●	●
-	●	-	-	●	-	●	●
○	●	○	○*	-	●	●	●
-	●	-	-	-	●	●	●
-	-	-	-	-	-	●	●
-	-	-	-	-	-	●	●

Function and construction project doors











for more security and convenience

Climate and apartment entrance doors

	WET system 1 ¹⁾	WET system 2	WET system 3
Door thickness approx.	40 mm	46 mm	52 mm
Max. dimensions	2110 × 985 mm	2235 × 1110 mm	2485 × 1235 mm ²⁾
Linkage door closer	○	○	○
Slide rail door closer	○	○	○
VarioFix frame	○	○	○
 Climatic class 3	●	●	●
 Acoustic rating category 1	●	-	-
 Acoustic rating category 2	-	●	-
 Acoustic rating category 3	-	●	●
 RC2 security features	-	○	○
 RC3 security features	-	-	●

● = Standard equipment ○ = Optional equipment

Fire-rated doors / smoke-tight doors

	Smoke-tight door ³⁾	T30 / EI ₂ 30 fire-rated door ⁴⁾	T30 garage connecting door	T90 / EI ₂ 90 fire-rated door ⁵⁾
Door thickness approx.	46 mm	50 mm	70 mm	70 mm
Max. dimensions	2235 × 1110 mm	2235 × 1235 mm	2235 × 1235 mm	2485 × 1235 mm
Linkage door closer	○	●	○	●
Slide rail door closer	●	○	●	○
 T30 / EI ₂ 30 fire-retarding	-	●	●	-
 T90 / EI ₂ 90 fire-proof	-	-	-	●
 Smoke protection	●	○	●	○
 Climatic class 2	-	●	-	●
 Climatic class 3	○	○	●	○
 Acoustic rating category 1	○	○	●	○
 Acoustic rating category 2	●	○	○	○
 Acoustic rating category 3	○	○	○	-
 RC2 security features	○	○	●	○
 RC3 security features	-	-	○	○

● = Standard equipment ○ = Optional equipment

¹⁾ Depending on door width and fitting position

²⁾ With RC3: 2235 × 1110 mm

³⁾ Only ProLine, other door versions on request

⁴⁾ Only for ProLine, Groove, Steel, Plain and ClassicLine Kontura

⁵⁾ Only for ProLine Duradecor



Spyhole 1

With an optional spyhole, you can see who is standing in front of your door at any time without having to open it.

Electric strike 2

With the optional electric strike catch, you can conveniently open your door via a switch inside the home.

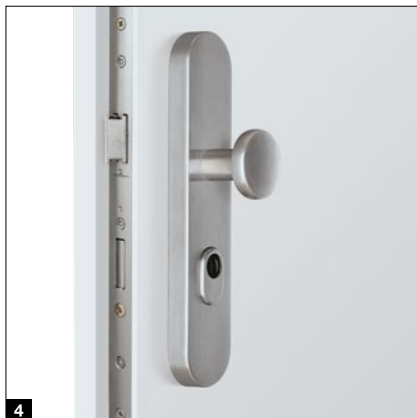

Lock equipment 3

Option of self-locking automatic lock or automatic door opener

Protective fitting 4

Option of long escutcheon / rose escutcheon ES 1 or long escutcheon / long escutcheon ES 2



Linkage door closer 5

As standard or optional for single-leaf doors (depending on design)

Slide rail door closer 6

As standard or optional for single-leaf and double-leaf doors (depending on design)



Fire protection lever 7

(Profile cylinder not included in the scope of delivery) As standard in black plastic, or option of stainless steel lever handle (see page 92).

Door lock operator SmartKey 8

Available in white or silver, incl. hand transmitter HSE 4 SK BS with labelled buttons.

Dimensions and fitting data

For timber doors

Door leaf

- Approx. 40 mm or 45 mm thick (for doors with real wood veneer)
- Frame construction made of solid timber / timber material with additional frame reinforcement, can be shortened by 25 mm at bottom
- For double-leaf doors: with counter rebate ¹⁾
- Climatic class I, duty category N to S (depending on version)
- Ready to hang acc. to DIN 18101
- Suitable for timber profile frames or standard frames made of steel

Frame

- Wall thickness adjustable
-5 mm / +15 mm or -5 / +10 mm (for doors with real wood veneer)
- Seal inserted at the factory, mitred

Frame dimensions

- A** Edge radius 3 mm
- B** Wall edges
 - 16 mm
 - 23 mm
- C** Cladding widths
 - 60 mm
 - 70 mm ²⁾
 - 80 mm
 - 100 mm
- D** Jamb lining
 - 25 mm thick

²⁾ Only available with 23 mm wall edge

Vertical view

Rebated

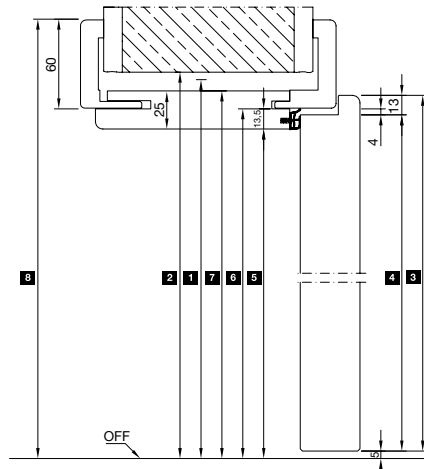

Flush

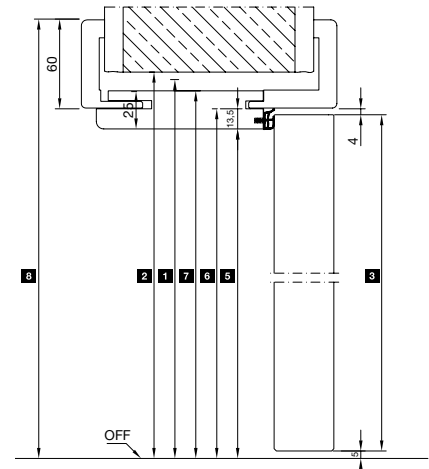

		1875	2000	2125	2250	
1	Nominal size height					
2	Wall opening	1880	2005	2130	2255	
3	Overall door leaf dimension	Rebated	1860	1985	2110	2235
		Flush	1847	1972	2097	2222
4	Leaf rebate dimension	1847	1972	2097	2222	
5	Clear passage dimension	1843	1968	2093	2218	
6	Frame hold dimension	1856	1981	2106	2231	
7	Overall lining dimension	1868	1993	2118	2243	
8	Overall frame dimension for 60 mm cladding (for 80 mm cladding + 20 mm)	1916	2041	2166	2291	

Frame types

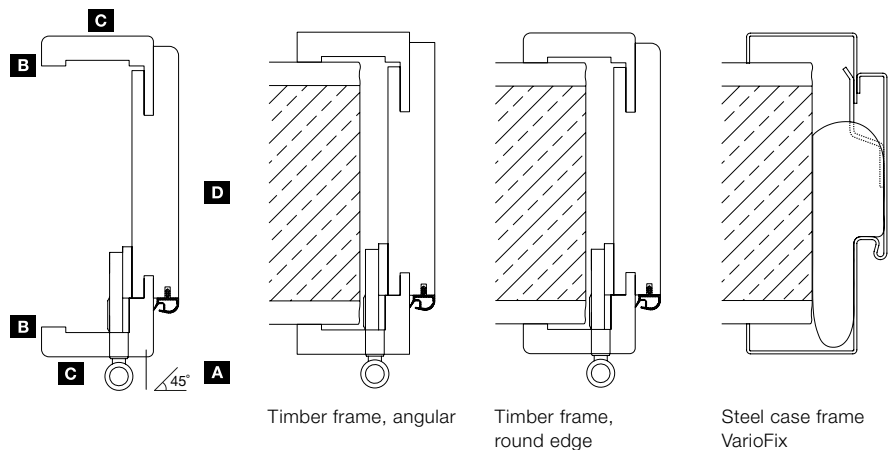

Dimensions in mm

¹⁾ For Carolina styles with meeting style

Horizontal view – single-leaf

Rebated

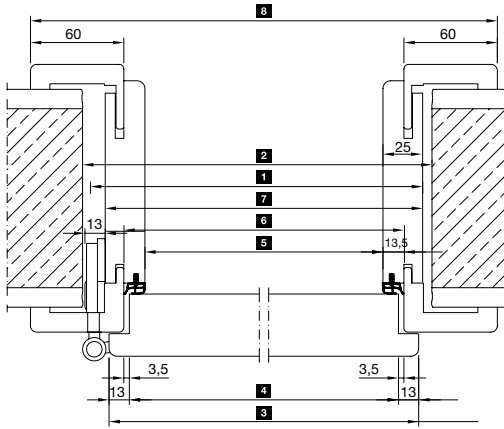

Flush

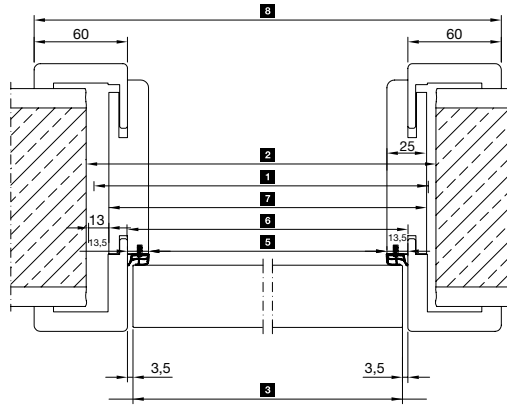

		625	750	875	1000	1125	1250	
1	Nominal size width							
2	Wall opening	635	760	885	1010	1135	1260	
3	Overall door leaf dimension	Rebated	610	735	860	985	1110	1235
		Flush	584	709	834	959	1084	1209
4	Leaf rebate dimension	584	709	834	959	1084	1209	
5	Clear passage dimension	564	689	814	939	1064	1189	
6	Frame hold dimension	591	716	841	966	1091	1216	
7	Overall lining dimension	614	739	864	989	1114	1239	
8	Overall frame dimension	711	836	961	1086	1211	1336	

Horizontal view – double-leaf

Rebated

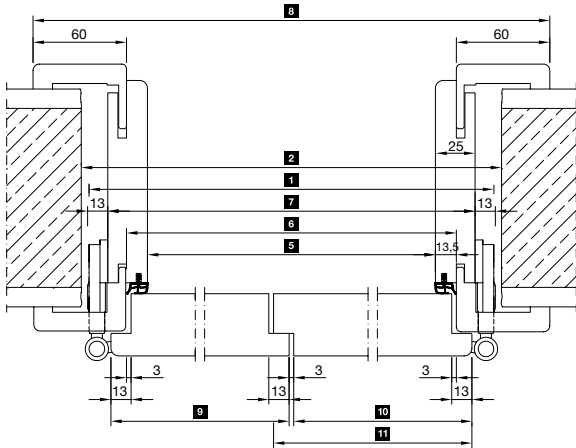

Flush

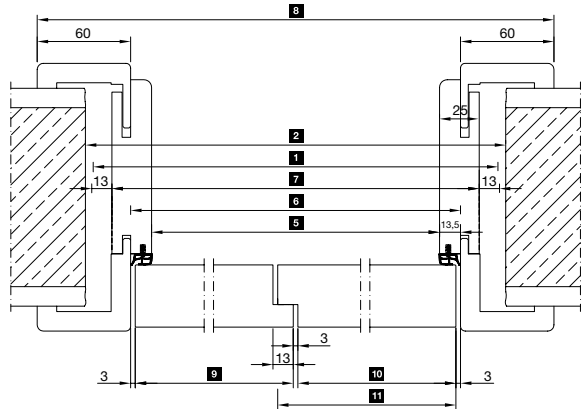

		1250	1375	1500	1750	1875	2000	2250	2500	
1	Nominal size width									
2	Wall opening	1260	1385	1510	1760	1885	2010	2260	2510	
5	Clear passage dimension	1176	1301	1426	1676	1801	1926	2176	2426	
6	Frame hold dimension	1203	1328	1453	1703	1828	1953	2203	2453	
7	Overall lining dimension	1226	1351	1476	1726	1851	1976	2226	2476	
8	Overall frame dimension	1323	1448	1573	1823	1948	2073	2323	2573	
3	Overall door leaf dimension Traffic leaf	Rebated	610	735	735	860	985	985	1110	1235
		Flush	597	722	722	847	972	972	1097	1222
3	Overall door leaf dimension Fixed leaf with meeting style ³⁾	Rebated	610	610	735	860	860	985	1110	1235
		Flush	597	597	722	847	847	972	1097	1222
3	Overall door leaf dimension Fixed leaf with counter rebate	Rebated	623	623	748	873	873	998	1123	1248
		Flush	610	610	735	860	860	985	1110	1235

Dimensions in mm

³⁾ Only for Carolina door styles

Dimensions and fitting data

ZeroLine frame

Vertical view with flush door leaf

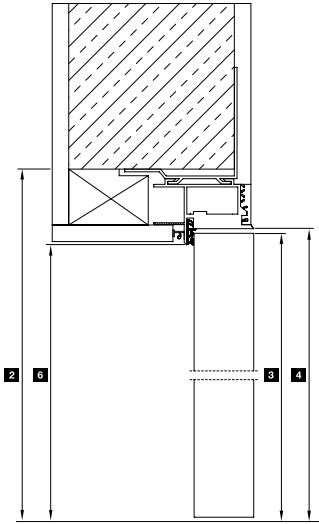

Horizontal view with flush door leaf

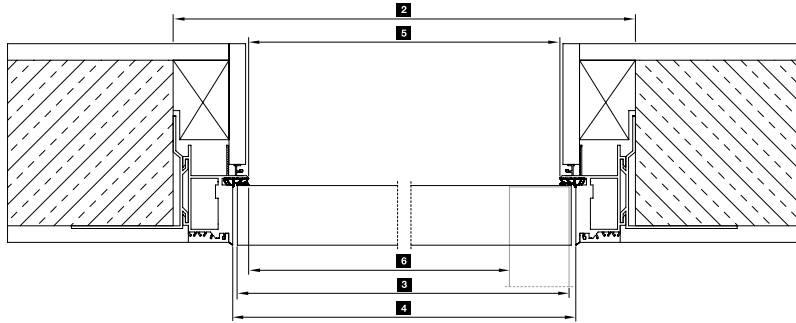

Vertical view with reverse-opening door leaf

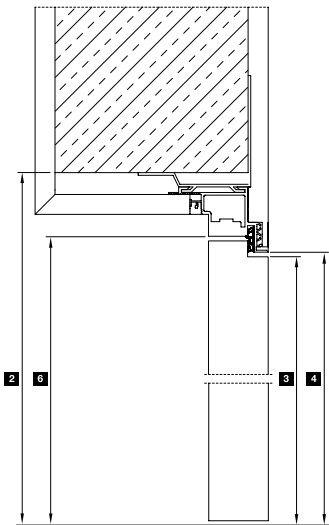

Horizontal view with reverse-opening door leaf

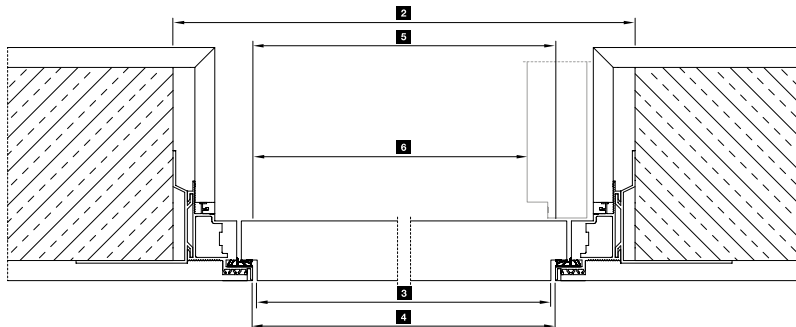

ZeroLine frame dimensions

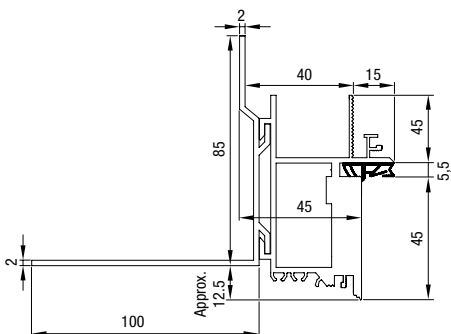

1	Nominal size width	750	875	1000	1125	921	1045
2	Wall opening	760	885	1010	1135	931	1055
3	Overall door leaf dimension ¹⁾	663	788	913	1038	834	958
4	Frame hold dimension ¹⁾	670	795	920	1045	841	965
5	Clear frame dimension ¹⁾	646	771	896	1021	817	941
6	Clear passage dimension ¹⁾	610	735	860	985	781	905
1	Nominal size height	2000	2125	2250	2026	2151	
2	Wall opening to OFF	2005	2130	2255	2031	2156	
3	Overall door leaf dimension ²⁾	1949	2074	2199	1975	2100	
4	Frame hold dimension to OFF ²⁾	1960	2085	2210	1986	2111	
5	Clear passage dimension to OFF ²⁾	1948	2073	2198	1974	2099	

All dimensions for ZeroLine frame with flush door leaf

¹⁾ For ZeroLine frame with reverse-opening door leaf – 6 mm

²⁾ For ZeroLine frame with reverse-opening door leaf – 3 mm

All dimensions in mm

Dimensions and fitting data

Reverse-opening doors

Vertical view

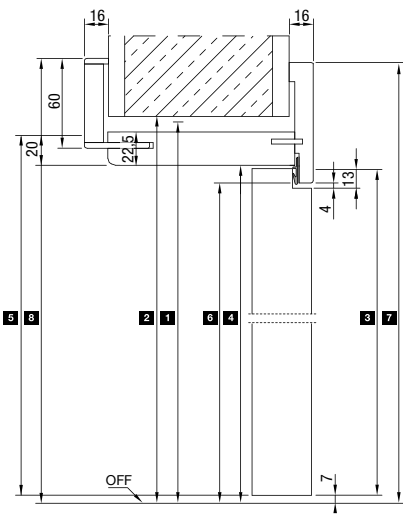

Horizontal views

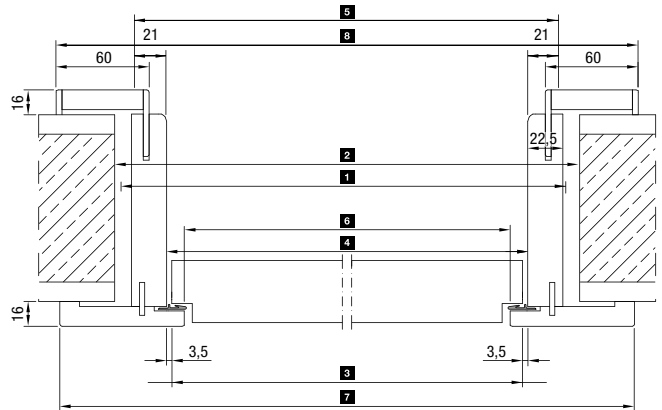

Closed

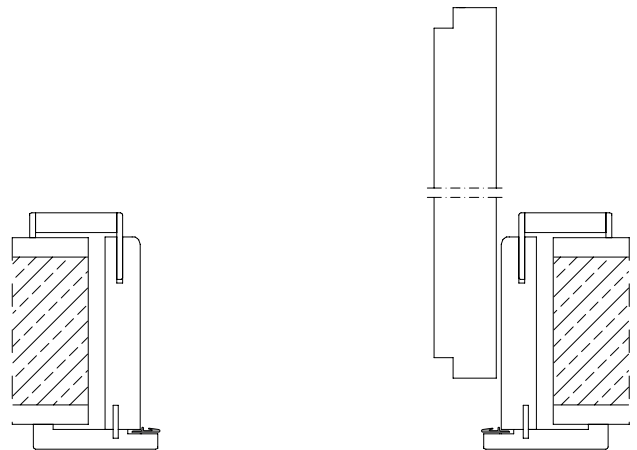

Open
(Left-hand hinged)

	min.					max.
1 Nominal size width	674	750	875	1000	1125	1174
2 Wall opening	684	760	885	1010	1135	1184
3 Overall door leaf dimension	610	686	811	936	1061	1110
4 Frame hold dimension	617	693	818	943	1068	1117
5 Frame nominal dimension	659	735	860	985	1110	1159
6 Clear passage dimension	594	670	795	920	1045	1094
7 Overall frame dimension side view	754	830	955	1080	1205	1254
8 Overall frame dimension opening side	760	836	961	1086	1211	1260
1 Nominal size height	1875	2000	2125	2250	2489	
2 Wall opening to OFF	1880	2005	2130	2255	2494	
3 Overall door leaf dimension	1835	1960	2085	2210	2449	
4 Frame hold dimension to OFF	1847	1972	2097	2222	2461	
5 Frame nominal dimension	1860	1985	2110	2235	2474	
6 Clear passage dimension to OFF	1836	1961	2086	2211	2450	
7 Overall frame dimension side view	1916	2041	2166	2291	2530	
8 Overall frame dimension opening side	1919	2044	2169	2294	2533	
					max.	

Experience Hörmann quality in new construction and modernisation

Hörmann products have impressive durability and high standards of functionality. They make it easy to plan for new construction and modernisation projects alike. The carefully coordinated solutions make your home more beautiful, more secure and more comfortable.

**GARAGE DOORS. GATE AND DOOR OPERATORS. ENTRANCE DOORS.
RESIDENTIAL INTERNAL DOORS. STEEL DOORS. FRAMES. STORAGE SPACE SYSTEMS.**



Some of the products shown are equipped with special equipment and do not always correspond to the standard versions. The surface finishes and colours shown are subject to the limitations of the printing process and cannot be regarded as binding. All rights reserved. No part may be reproduced without our prior permission. Subject to changes.